

Rev. 00

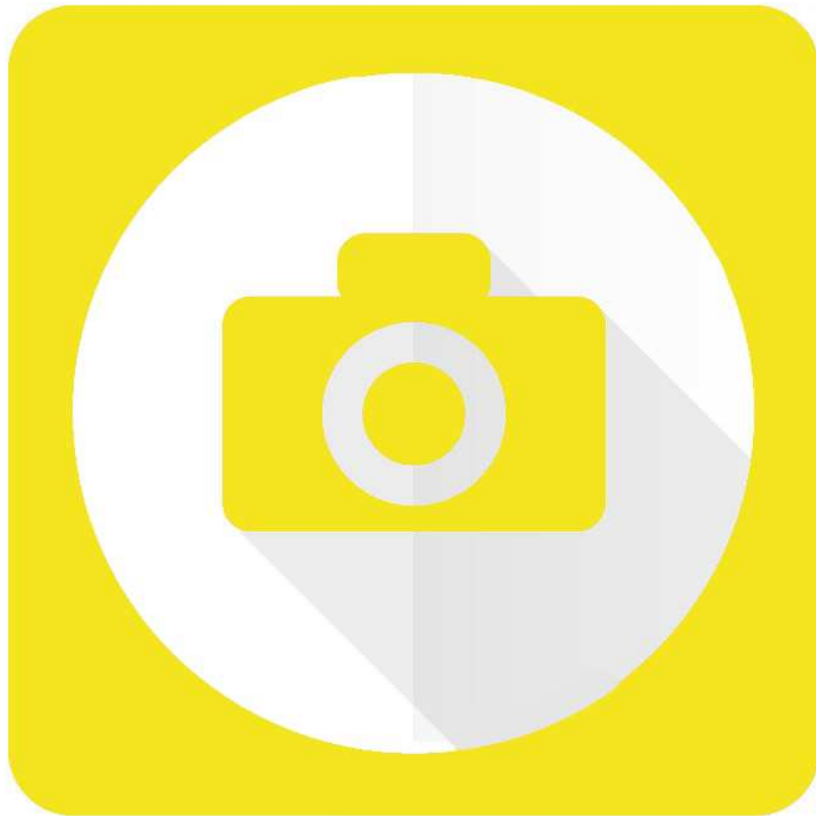

**ASSERVIMENTI PER PRESSE**  
***EQUIPMENT FOR PRESSES***

# **ASSERVIMENTI per PRESSE** ***EQUIPMENT for PRESSES***

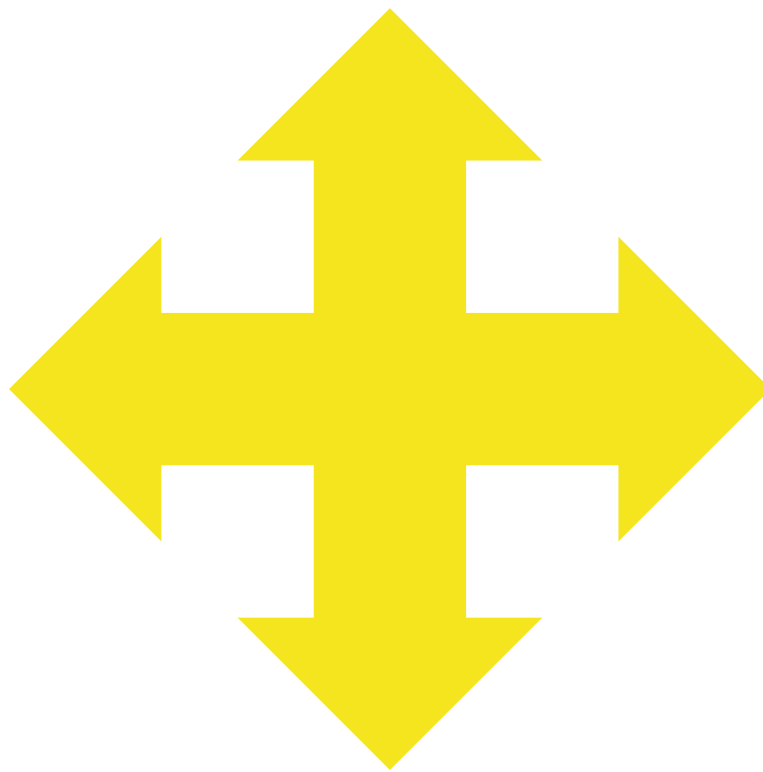

# **ASSERVIMENTI per PRESSE**

## ***EQUIPMENT for PRESSES***

### **INDICE**

### ***INDEX***

**Pagina**  
**Page**

**VALVOLE DI SICUREZZA PRESSE** 4 - 5  
***SAFETY VALVES FOR PRESSES***

**ALIMENTATORI PNEUMATICI PICCOLI SERIE "A"** 8 - 13  
***SMALL PNEUMATIC FEEDERS "A" SERIES***

**ALIMENTATORI PNEUMATICI SERIE "AN"- "ANM"-** 14 - 43  
**"AMC"- "AM2C"- "ANDCB"**  
***PNEUMATIC FEEDERS "AN"- "ANM"- "AMC"-***  
***"AM2C"- "ANDCB" SERIES***

**ALIMENTATORI CNC SERIE "ANM-E"** 44 - 49  
***CNC CLAMP FEEDERS "ANM-E" SERIES***

**ALIMENTATORI ELETTRONICI A RULLI** 48 - 49  
***ELECTRONIC ROLL FEEDS***

**ASPI SVOLGITORI** 50 - 57  
***DECOILERS***



# VALVOLE DI SICUREZZA PRESSE SAFETY VALVES FOR PRESSES

<https://youtu.be/32vztw33prU>

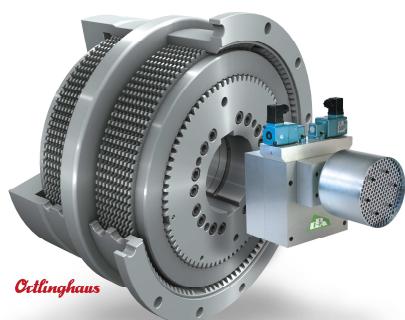

Cetlinghaus

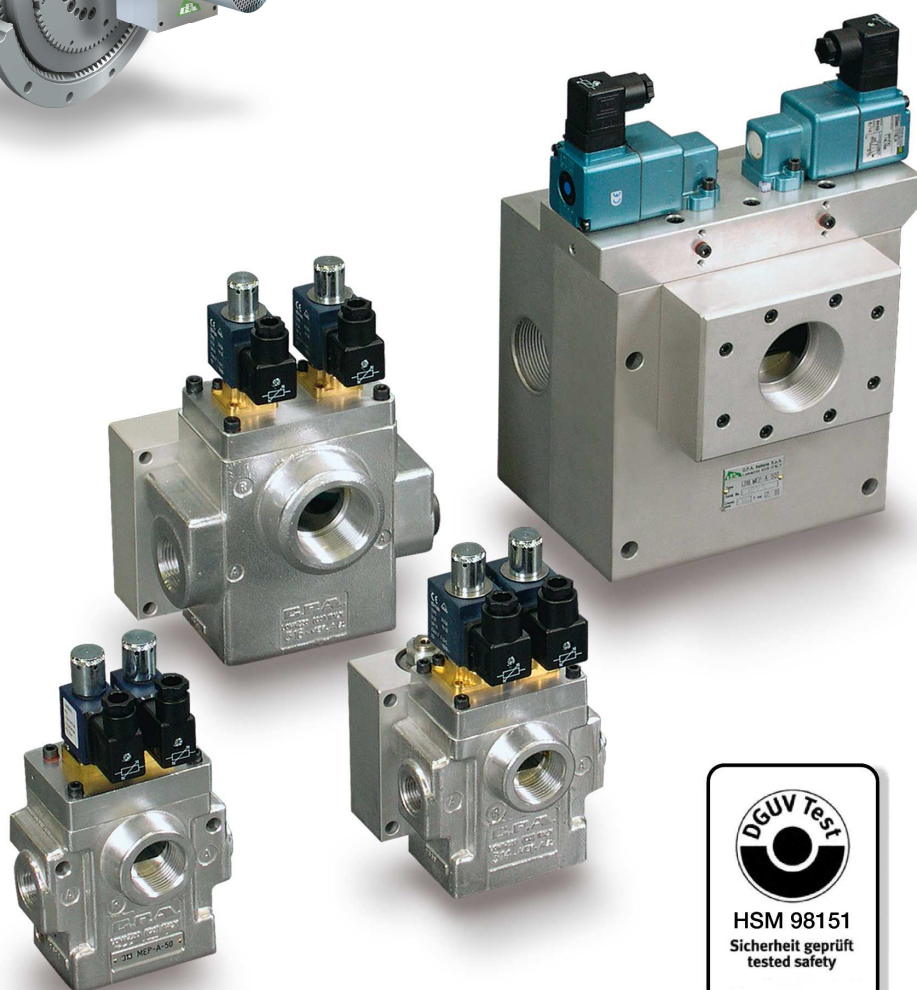

# VALVOLE DI SICUREZZA PRESSE SAFETY VALVES FOR PRESSES

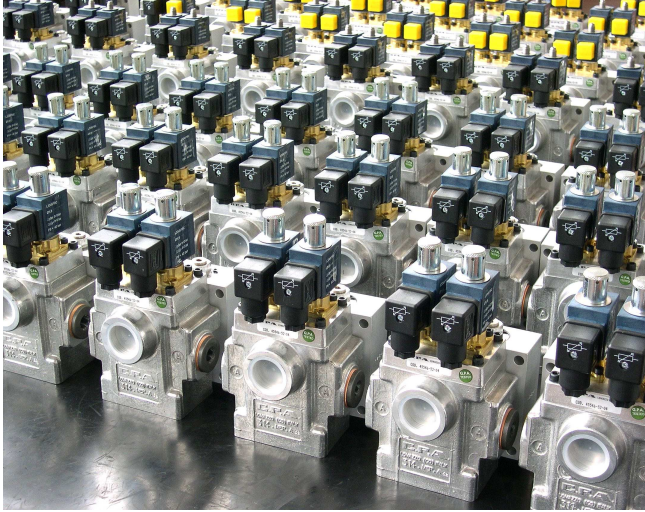

# ASSERVIMENTI per PRESSE *EQUIPMENT for PRESSES*

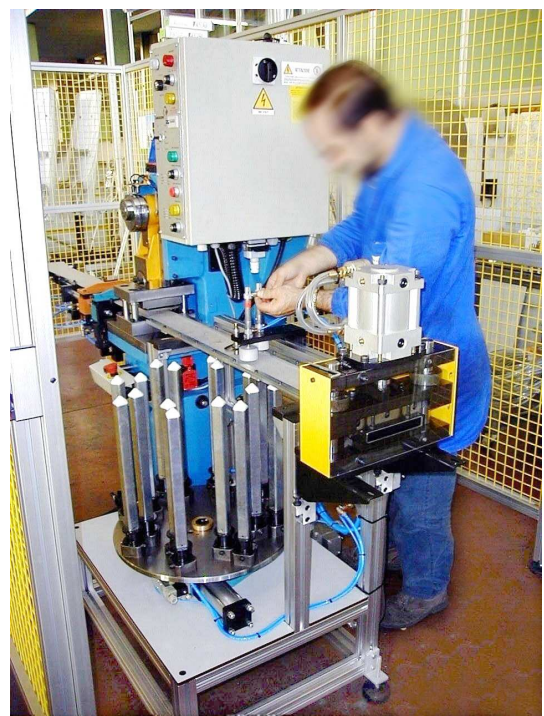
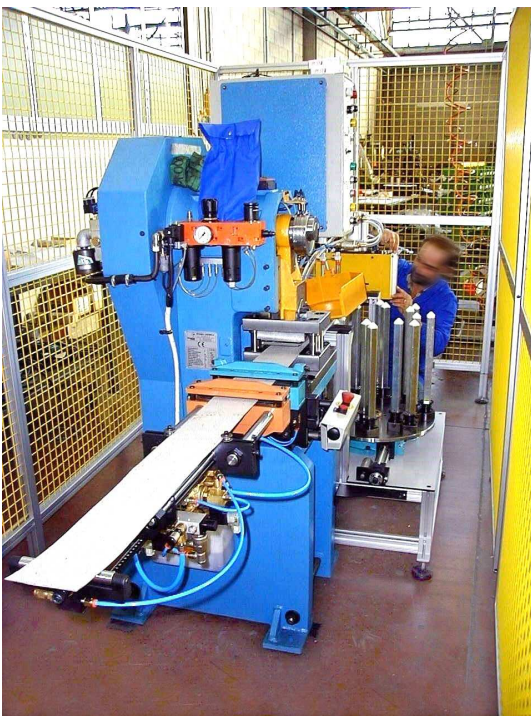

# ASSERVIMENTI per PRESSE *EQUIPMENT for PRESSES*

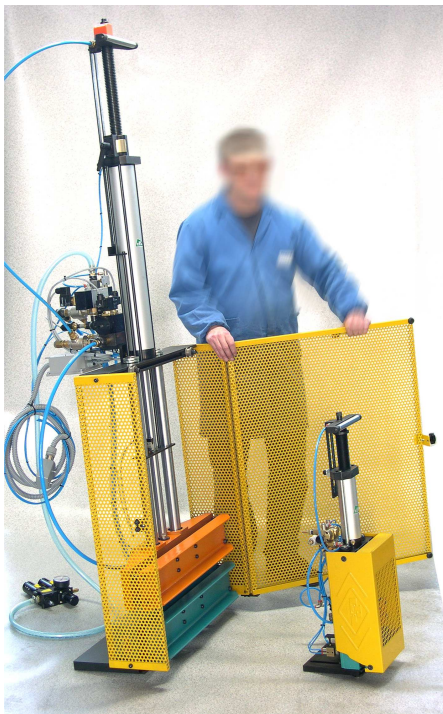

# ALIMENTATORI PNEUMATICI PICCOLI SERIE "A" SMALL PNEUMATIC FEEDERS "A" SERIES

<https://youtu.be/Mlb-PPwKoJo>

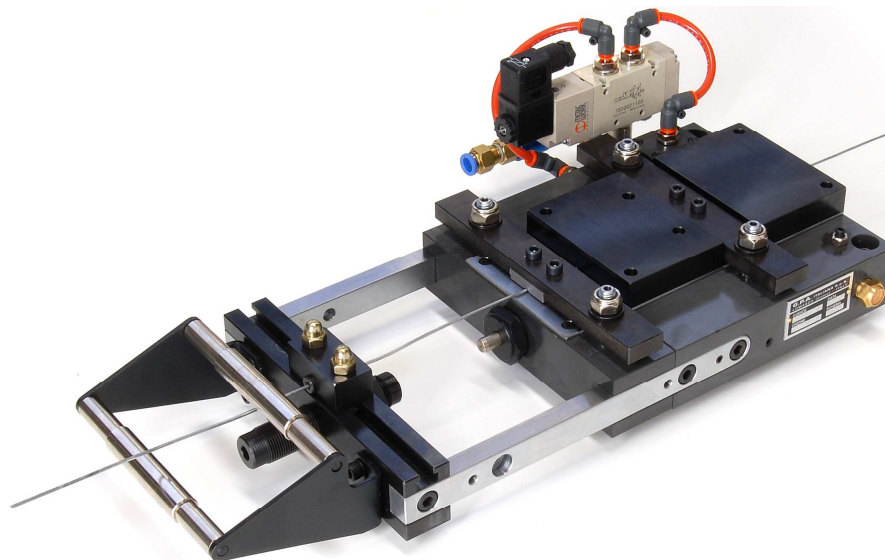
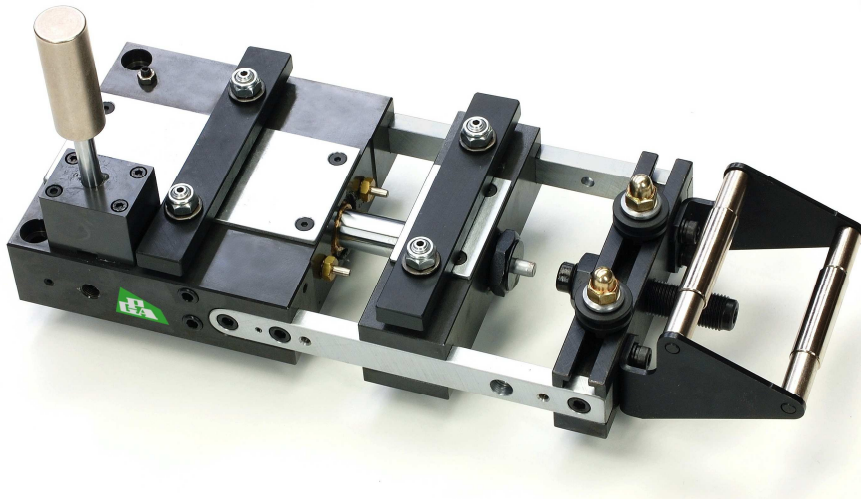

- Alimentatore compatto serie "A" per nastro e filo
- "A" series compact feeder for band and wire





# ALIMENTATORI PNEUMATICI PICCOLI SERIE "A" SMALL PNEUMATIC FEEDERS "A" SERIES

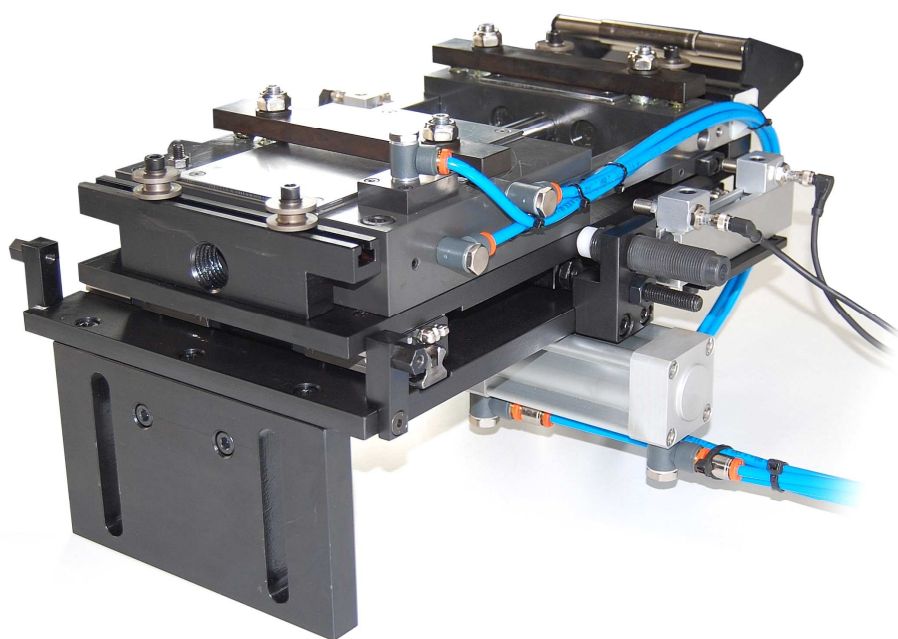
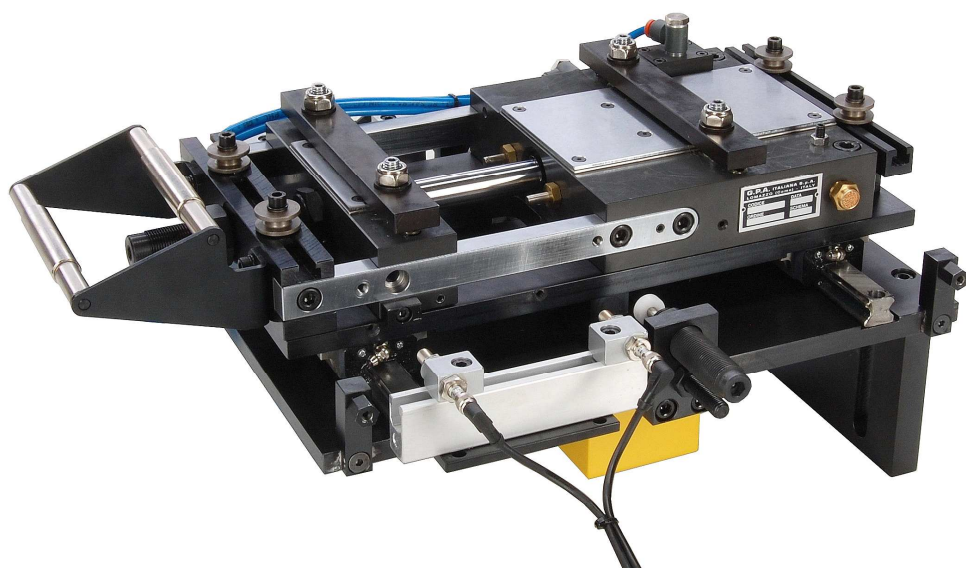

- Alimentatore compatto serie "A" ZIG-ZAG avanzamento mm 100, laterale mm 50
- "A" series compact feeder ZIG-ZAG stroke mm 100 lateral mm 50



# ALIMENTATORI PNEUMATICI PICCOLI SERIE "A" *SMALL PNEUMATIC FEEDERS "A" SERIES*

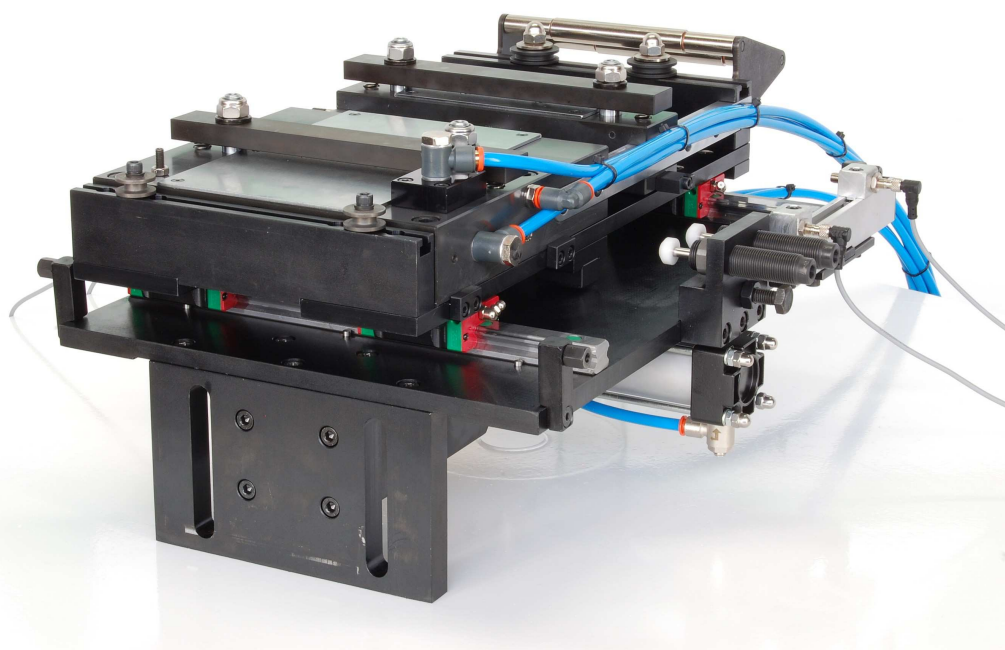
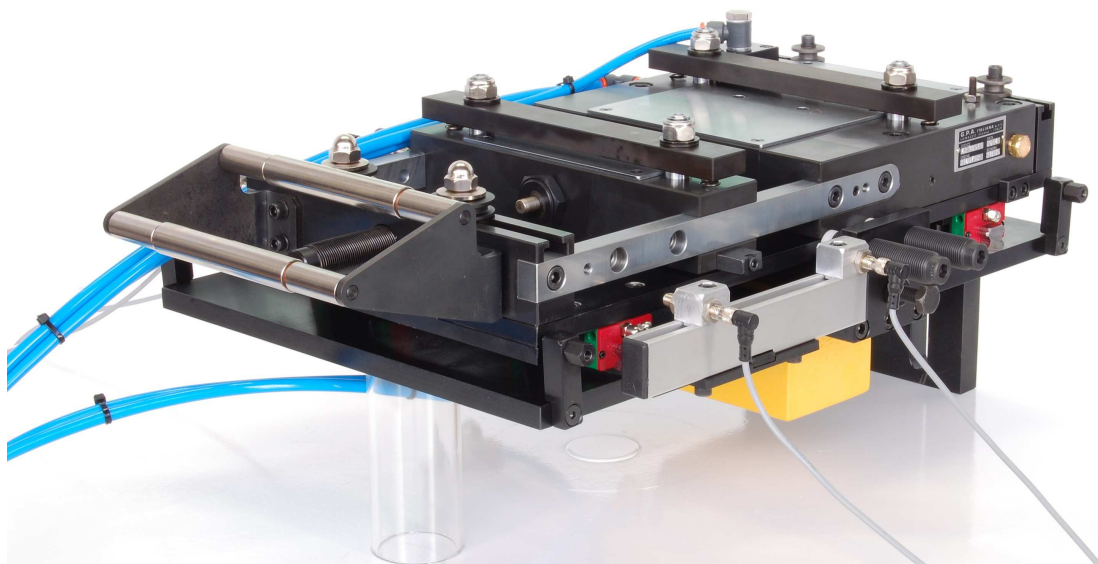

Photo: AP 010-00



# ALIMENTATORI PNEUMATICI PICCOLI SERIE "A" *SMALL PNEUMATIC FEEDERS "A" SERIES*

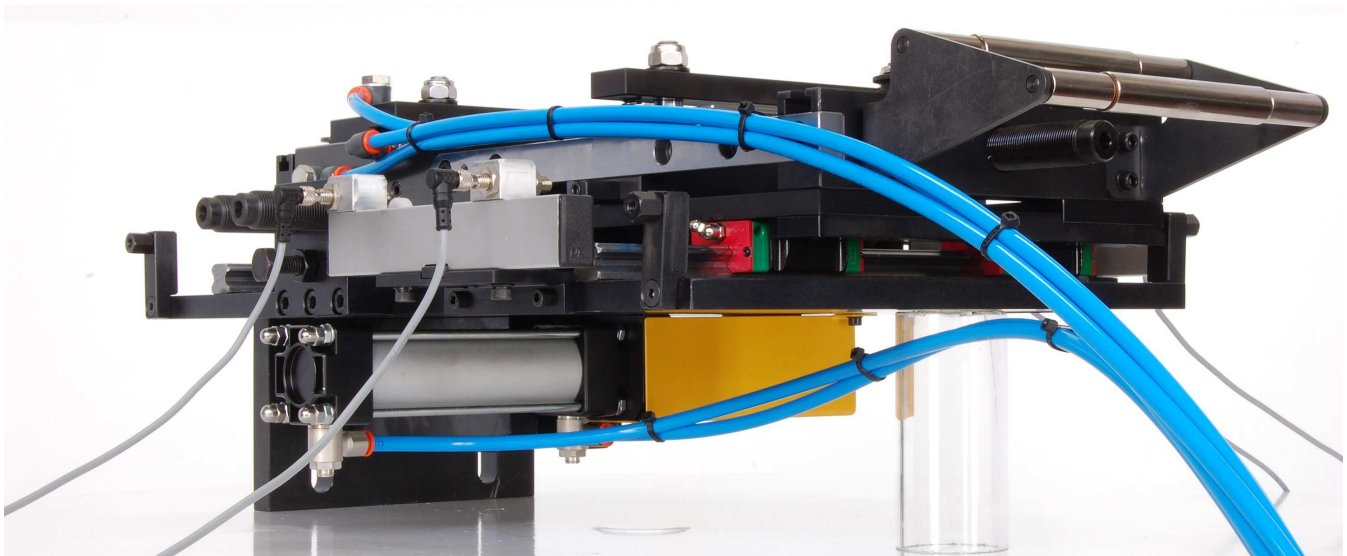
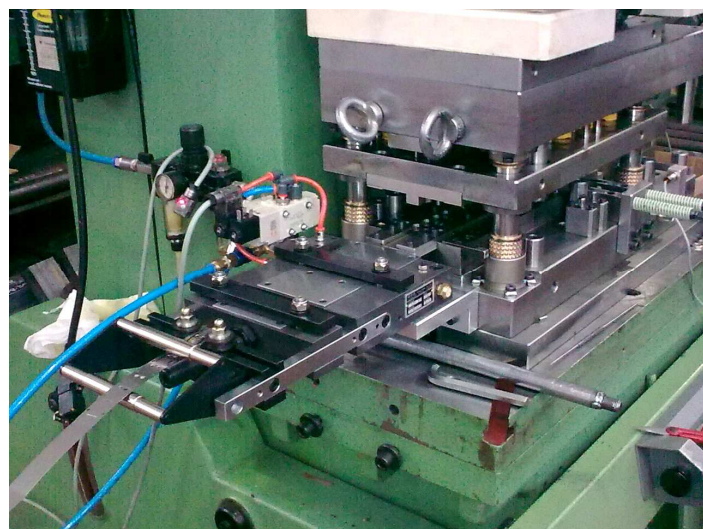
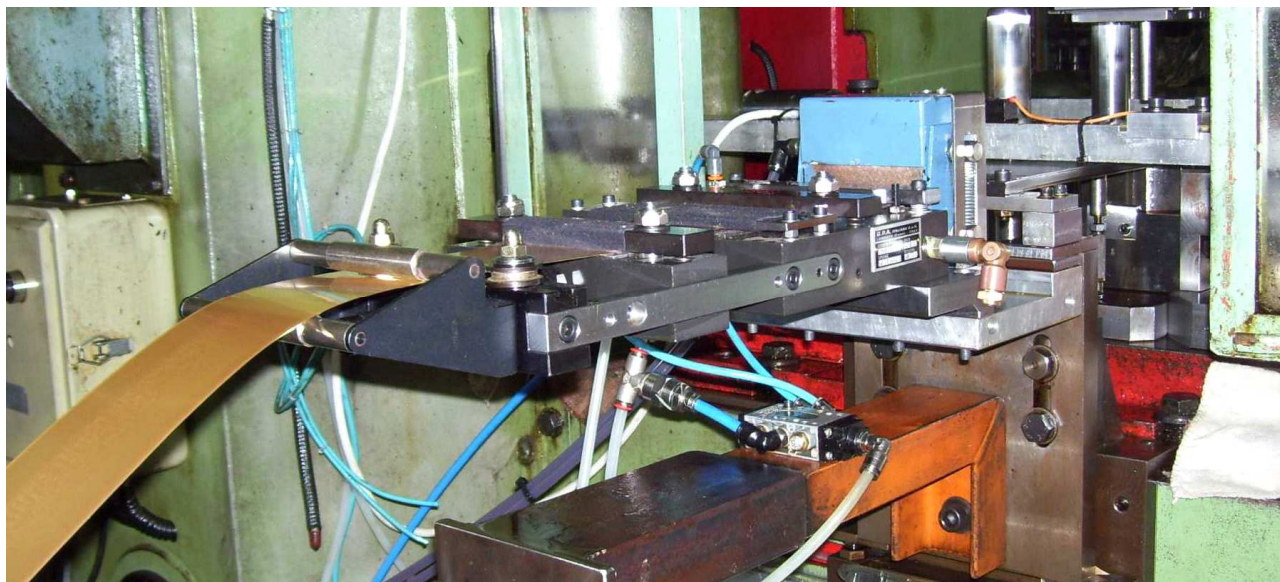

Photo: AP 011-00



# ALIMENTATORI PNEUMATICI PICCOLI SERIE "A" SMALL PNEUMATIC FEEDERS "A" SERIES

<https://youtu.be/IS0NrfQIO4g>



- Esempi di installazioni alimentatore "A"
- "A" series compact feeder installation examples



# ALIMENTATORI PNEUMATICI PICCOLI SERIE "A" SMALL PNEUMATIC FEEDERS "A" SERIES

<https://youtu.be/oQOUX41KEYY>



- Installazione alimentatore "A" ZIG-ZAG su transfer
- *"A" series compact feeder ZIG-ZAG installation on transfer*



**ALIMENTATORI PNEUMATICI "AN"- "ANM"- "AMC"- "AM2C"- "ANDCB"**  
**PNEUMATIC FEEDERS "AN"- "ANM"- "AMC"- "AM2C"- "ANDCB"**

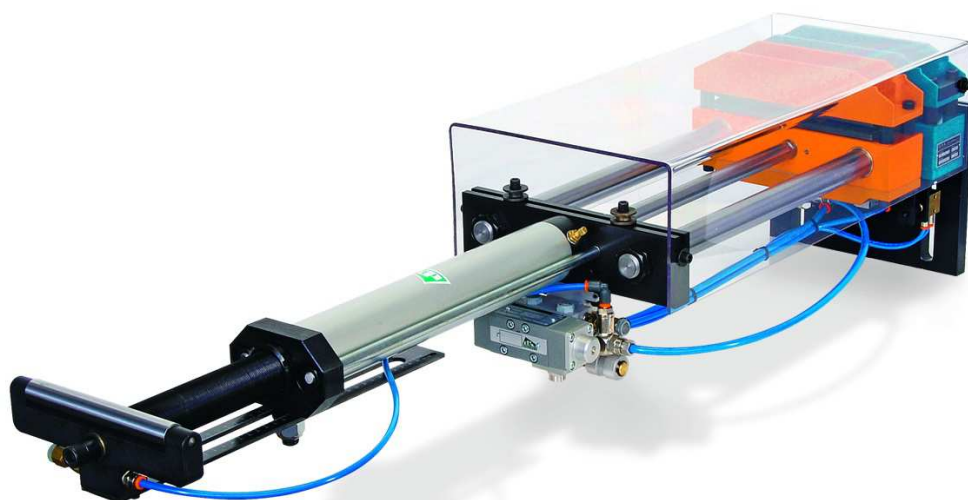

**AN**

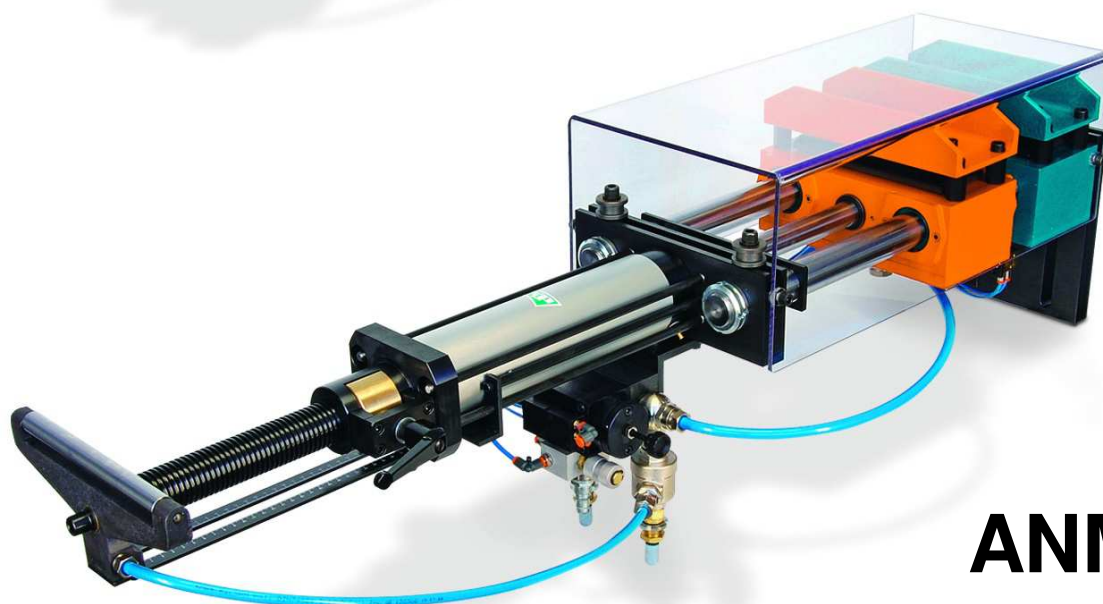

**ANM**



**ALIMENTATORI PNEUMATICI “AN”-“ANM”-“AMC”-“AM2C”-“ANDCB”**  
**PNEUMATIC FEEDERS “AN”-“ANM”-“AMC”- “AM2C”-“ANDCB”**

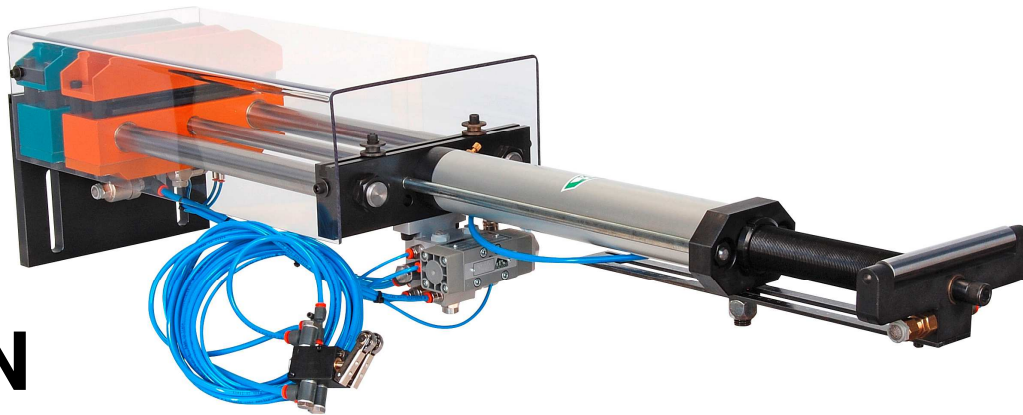

**AN**



**ANM**



**ALIMENTATORI PNEUMATICI "AN"- "ANM"- "AMC"- "AM2C"- "ANDCB"**  
**PNEUMATIC FEEDERS "AN"- "ANM"- "AMC"- "AM2C"- "ANDCB"**

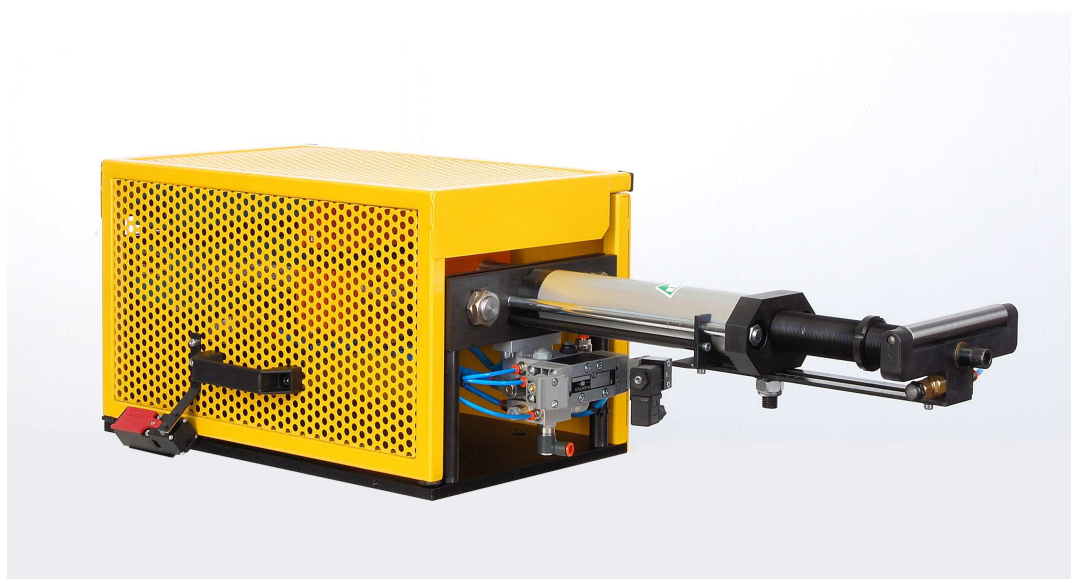
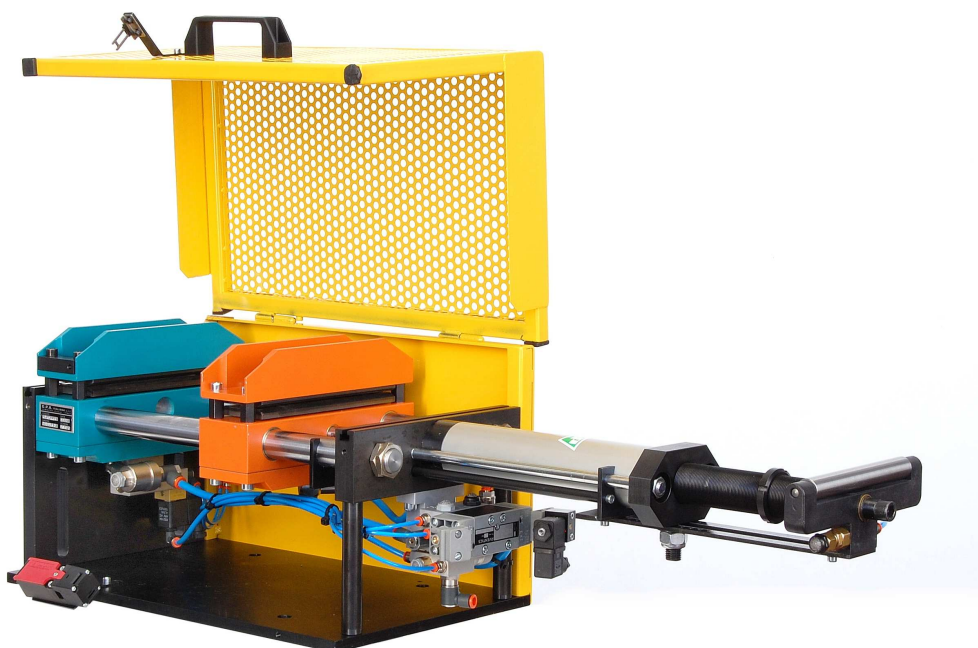

Photo: AP 016-00





**ALIMENTATORI PNEUMATICI "AN"- "ANM"- "AMC"- "AM2C"- "ANDCB"**  
**PNEUMATIC FEEDERS "AN"- "ANM"- "AMC"- "AM2C"- "ANDCB"**



Photo: AP 017-00



**ALIMENTATORI PNEUMATICI "AN"- "ANM"- "AMC"- "AM2C"- "ANDCB"**  
**PNEUMATIC FEEDERS "AN"- "ANM"- "AMC"- "AM2C"- "ANDCB"**

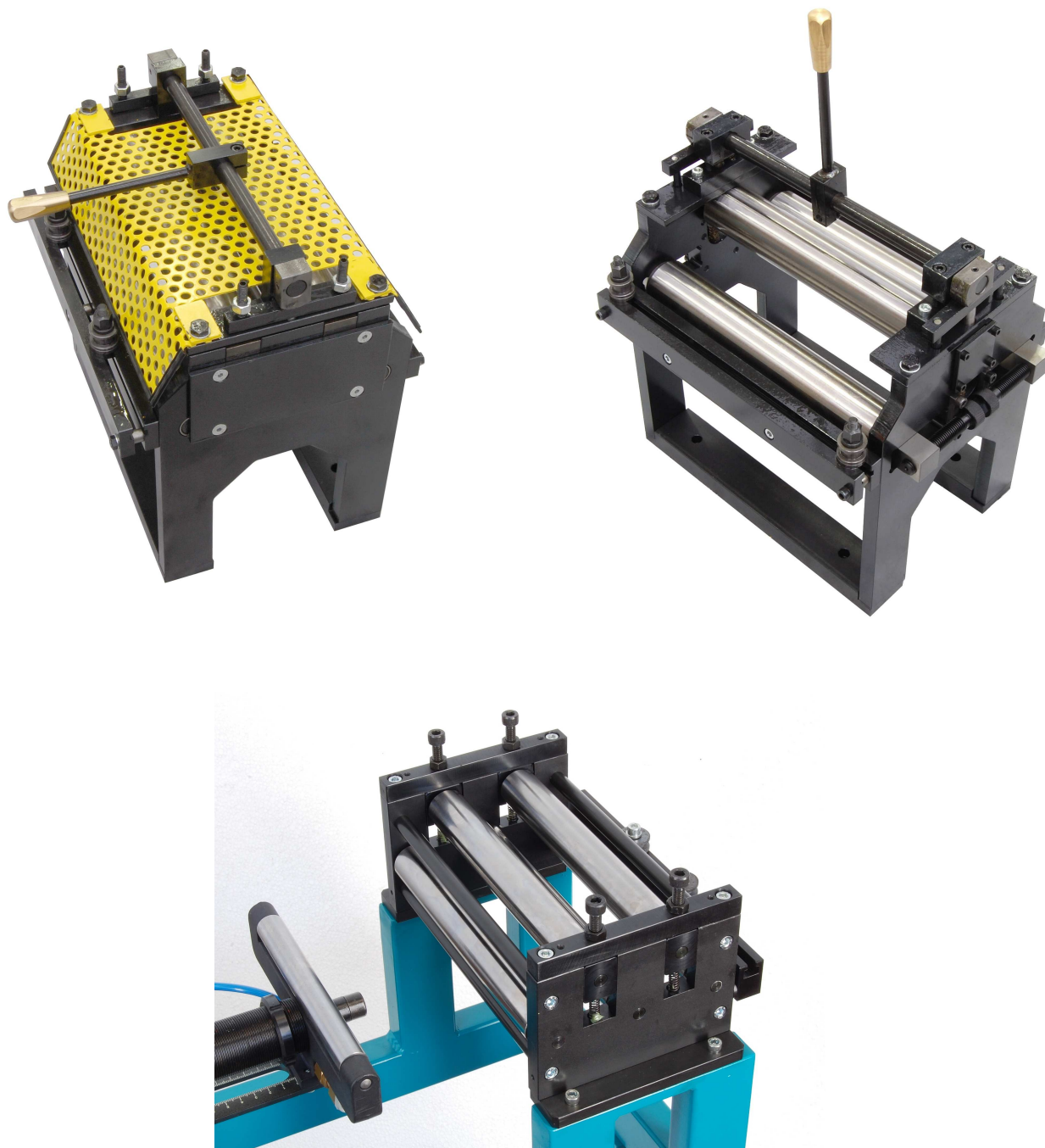

Photo: AP 018-00



# ALIMENTATORI PNEUMATICI "AN"- "ANM"- "AMC"- "AM2C"- "ANDCB" PNEUMATIC FEEDERS "AN"- "ANM"- "AMC"- "AM2C"- "ANDCB"

<https://youtu.be/4CeNb2-06XA>

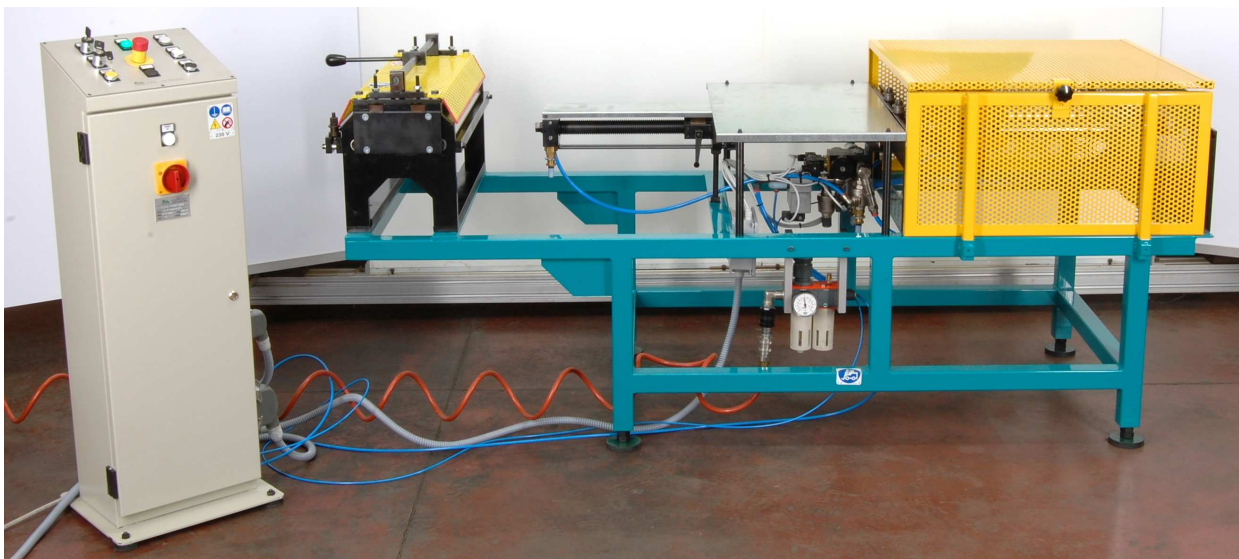
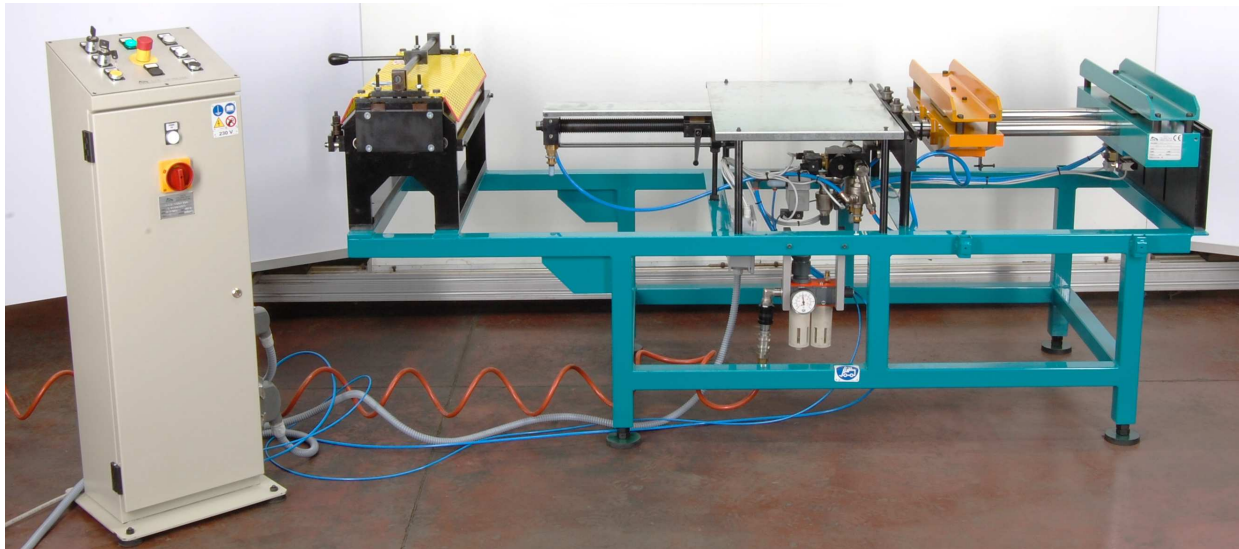

Photo: AP 019-00



**ALIMENTATORI PNEUMATICI “AN”-“ANM”-“AMC”-“AM2C”-“ANDCB”**  
**PNEUMATIC FEEDERS “AN”-“ANM”-“AMC”- “AM2C”-“ANDCB”**

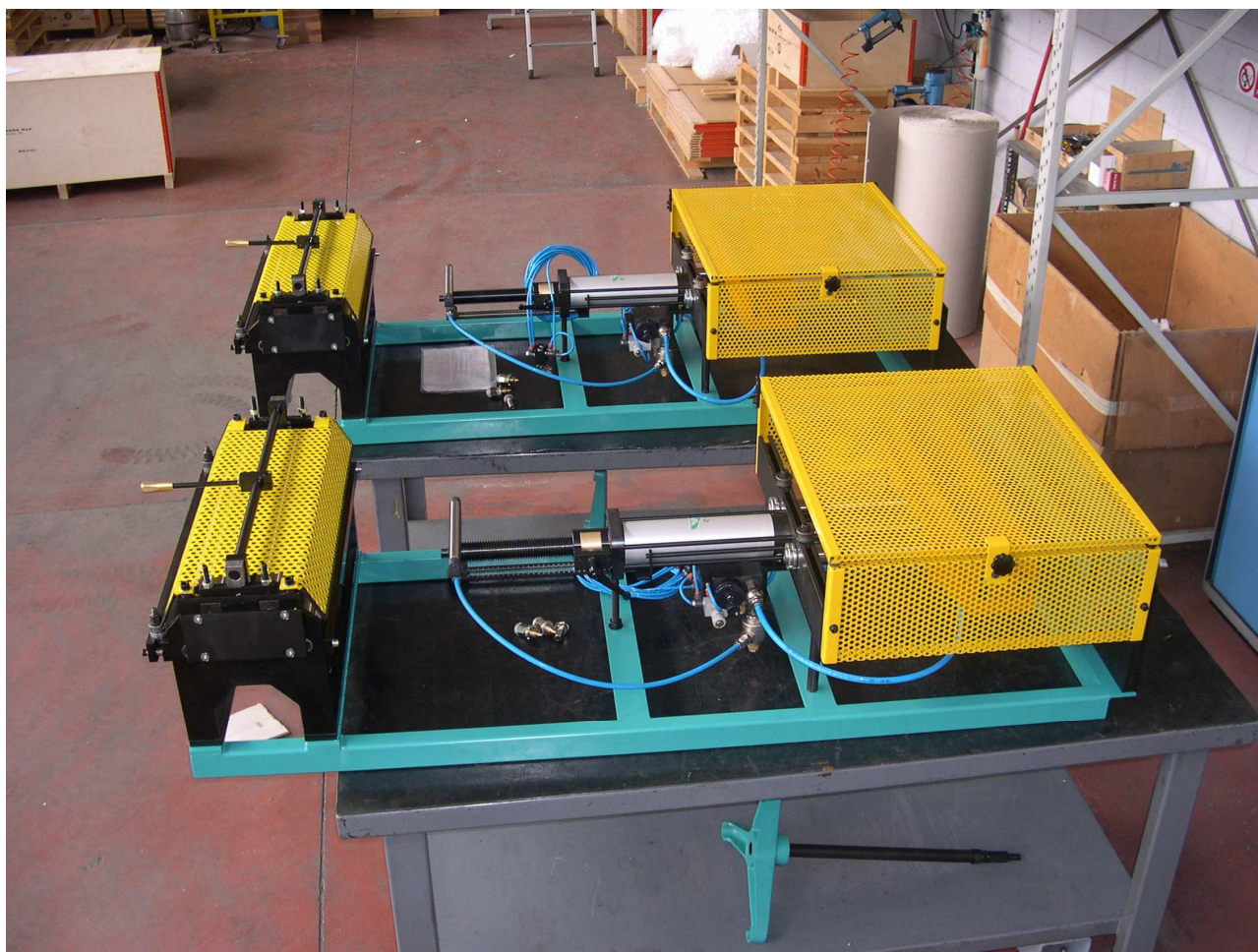

Photo: AP 020-00



# ALIMENTATORI PNEUMATICI “AN”-“ANM”-“AMC”-“AM2C”-“ANDCB” PNEUMATIC FEEDERS “AN”-“ANM”-“AMC”- “AM2C”-“ANDCB”



- Alimentatore pneumatico serie ANM con cambio passo motorizzato
- *ANM series pneumatic feeder with motorized change stroke*



**ALIMENTATORI PNEUMATICI “AN”-“ANM”-“AMC”-“AM2C”-“ANDCB”**  
**PNEUMATIC FEEDERS “AN”-“ANM”-“AMC”- “AM2C”-“ANDCB”**



- Alimentatore pneumatico serie ANM con cambio passo motorizzato
- *ANM series pneumatic feeder with motorized change stroke*



# ALIMENTATORI PNEUMATICI “AN”-“ANM”-“AMC”-“AM2C”-“ANDCB”

## PNEUMATIC FEEDERS “AN”-“ANM”-“AMC”- “AM2C”-“ANDCB”



- Linea alimentazione con cesoia interfacciata a robot
- *Feeder line with shears and robot*



# ALIMENTATORI PNEUMATICI "AN"- "ANM"- "AMC"- "AM2C"- "ANDCB" PNEUMATIC FEEDERS "AN"- "ANM"- "AMC"- "AM2C"- "ANDCB"

<https://youtu.be/N-bmIQluP1c>



Photo: AP 024-00





# ALIMENTATORI PNEUMATICI "AN"- "ANM"- "AMC"- "AM2C"- "ANDCB" PNEUMATIC FEEDERS "AN"- "ANM"- "AMC"- "AM2C"- "ANDCB"

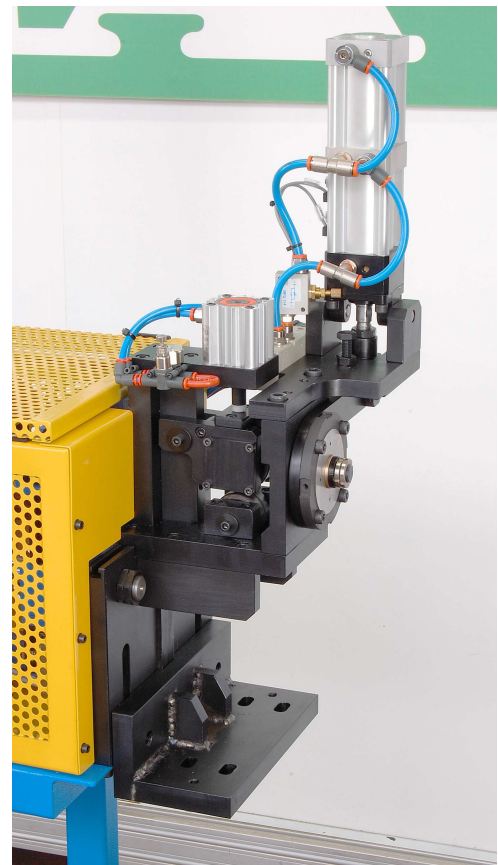
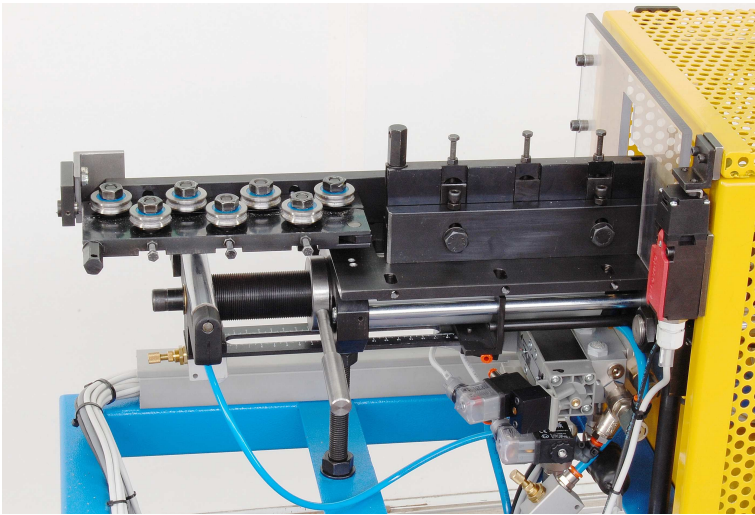

Photo: AP 025-00



# ALIMENTATORI PNEUMATICI "AN"- "ANM"- "AMC"- "AM2C"- "ANDCB" PNEUMATIC FEEDERS "AN"- "ANM"- "AMC"- "AM2C"- "ANDCB"

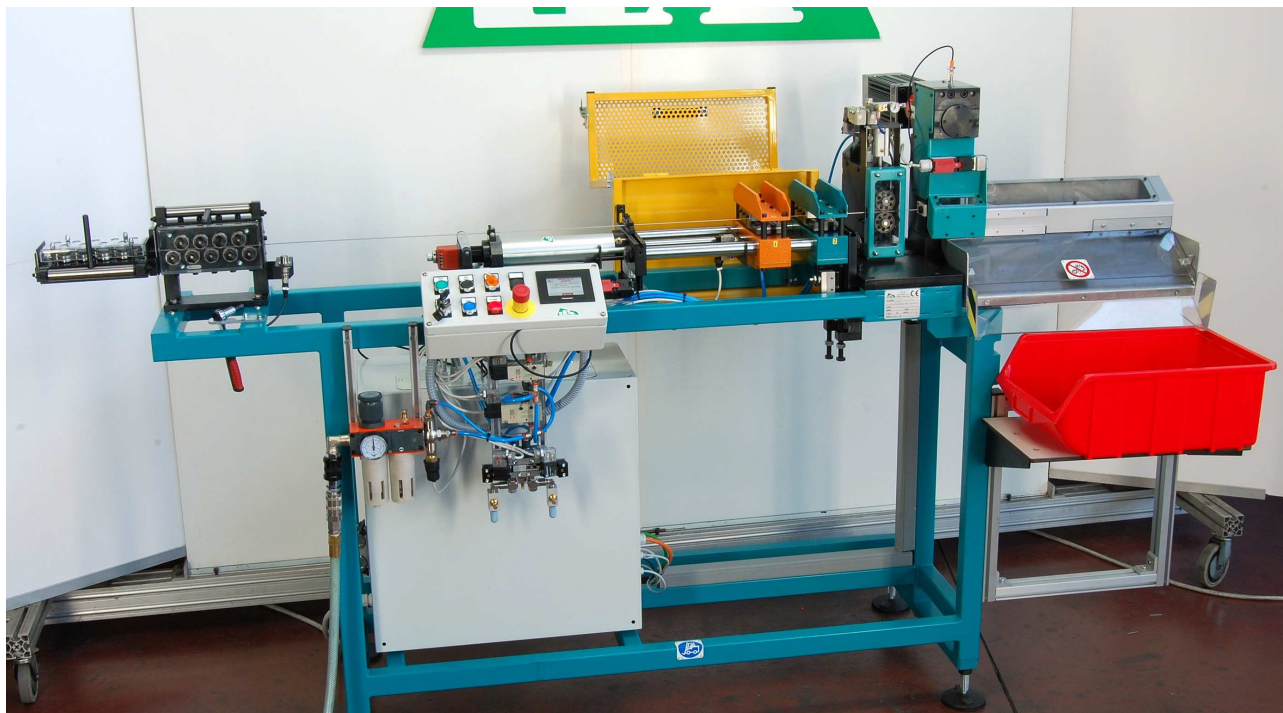

Photo: AP 026-00



**ALIMENTATORI PNEUMATICI “AN”-“ANM”-“AMC”-“AM2C”-“ANDCB”**  
**PNEUMATIC FEEDERS “AN”-“ANM”-“AMC”- “AM2C”-“ANDCB”**



Photo: AP 027-00



## **ALIMENTATORI PNEUMATICI “AN”-“ANM”-“AMC”-“AM2C”-“ANDCB”** **PNEUMATIC FEEDERS “AN”-“ANM”-“AMC”- “AM2C”-“ANDCB”**



- Alimentatore pneumatico serie AN 200x400, raddrizzatrice folle, cesoia pneumatica da 8 kN, quadro elettronico programmazione avanzamenti lotto di taglio
- *AN200x400 series pneumatic feeder, undriven straightener, 8 kN pneumatic shears, programmable cutting batch electronic board*



# ALIMENTATORI PNEUMATICI “AN”-“ANM”-“AMC”-“AM2C”-“ANDCB” PNEUMATIC FEEDERS “AN”-“ANM”-“AMC”- “AM2C”-“ANDCB”



- Alimentatore pneumatico serie AN 300x600 con quadro elettrico interfaccia pressa
- *AN300x600 series pneumatic feeder with electric control board press interface*



# ALIMENTATORI PNEUMATICI "AN"- "ANM"- "AMC"- "AM2C"- "ANDCB" PNEUMATIC FEEDERS "AN"- "ANM"- "AMC"- "AM2C"- "ANDCB"

[https://youtu.be/YS5somm\\_XwU](https://youtu.be/YS5somm_XwU)



Photo: AP 030-00



**ALIMENTATORI PNEUMATICI “AN”-“ANM”-“AMC”-“AM2C”-“ANDCB”**  
**PNEUMATIC FEEDERS “AN”-“ANM”-“AMC”- “AM2C”-“ANDCB”**

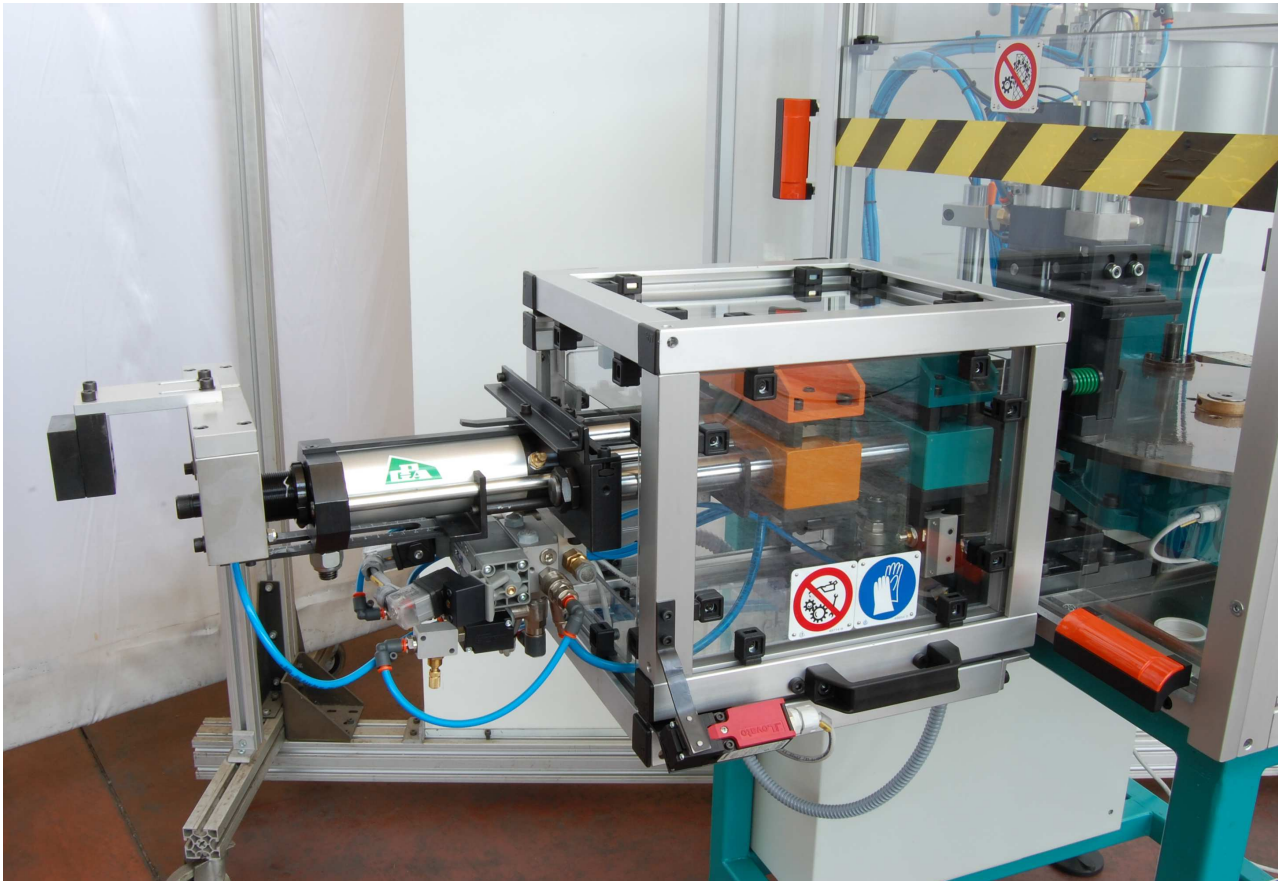
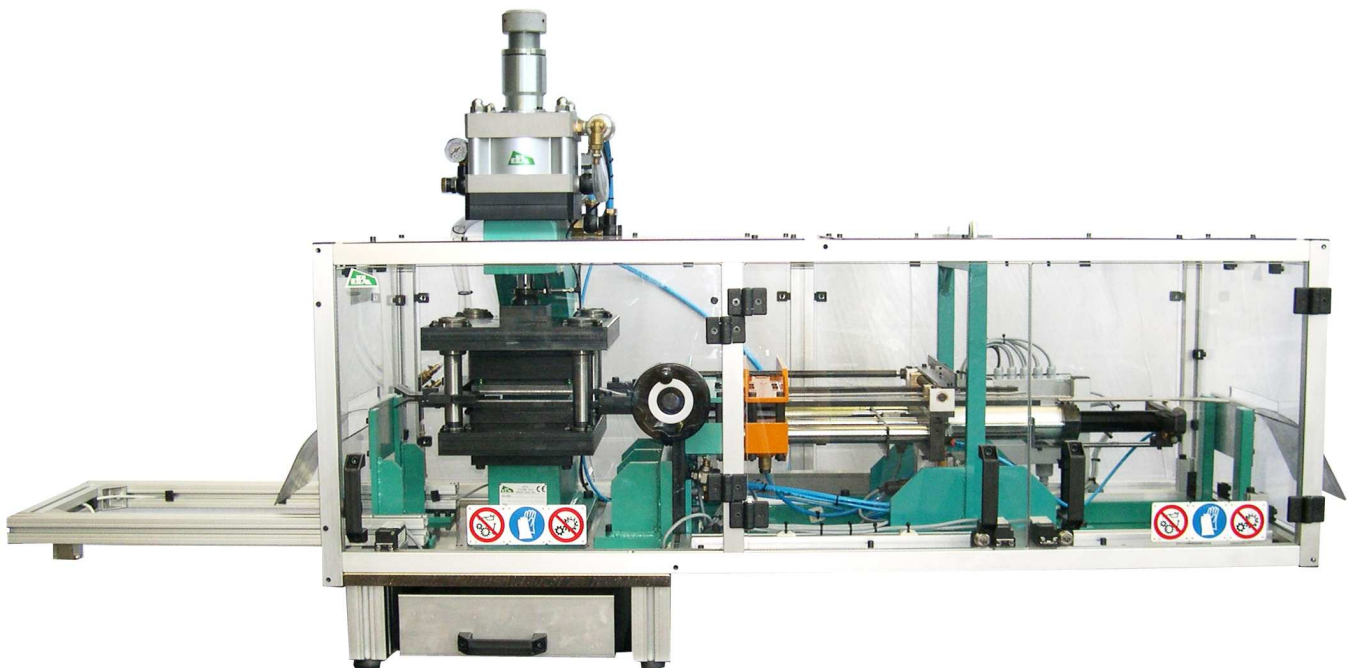

Photo: AP 031-00



**ALIMENTATORI PNEUMATICI “AN”-“ANM”-“AMC”-“AM2C”-“ANDCB”**  
**PNEUMATIC FEEDERS “AN”-“ANM”-“AMC”- “AM2C”-“ANDCB”**



- Linea compatta alimentatore 200x100, pressa pneumatica kN 10, ciclo di lavorazione automatico
- *200x100 feeder compact line, kN 10 pneumatic press, automatic working cycle*





# ALIMENTATORI PNEUMATICI “AN”-“ANM”-“AMC”-“AM2C”-“ANDCB” PNEUMATIC FEEDERS “AN”-“ANM”-“AMC”- “AM2C”-“ANDCB”



- Alimentatore pneumatico insonorizzato in abbinamento a pressa idropneumatica da 240 kN
- *Soundproof pneumatic feeder with hydropneumatic 240 kN press*



**ALIMENTATORI PNEUMATICI “AN”-“ANM”-“AMC”-“AM2C”-“ANDCB”**  
**PNEUMATIC FEEDERS “AN”-“ANM”-“AMC”- “AM2C”-“ANDCB”**

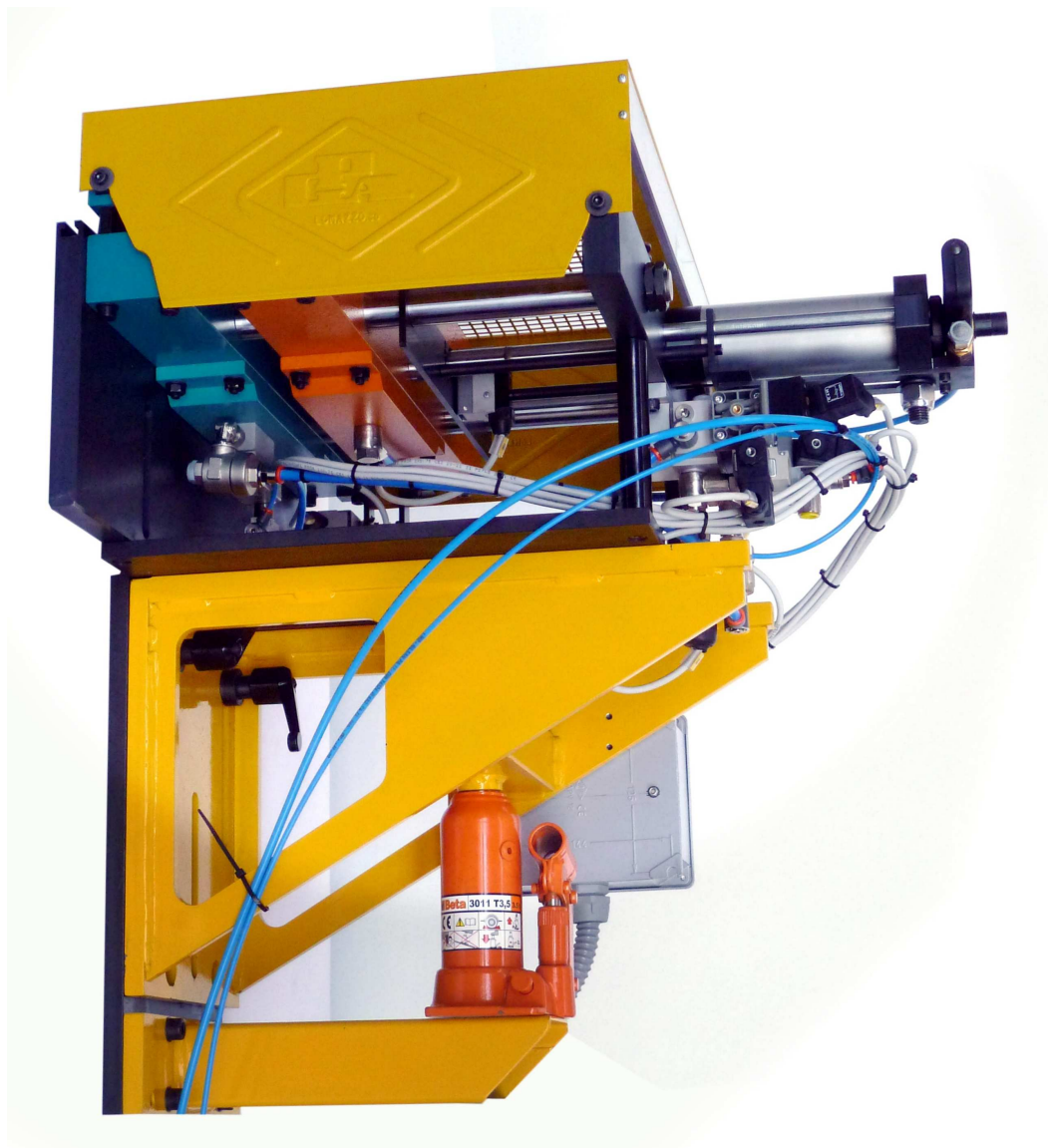

Photo: AP 034-00



# ALIMENTATORI PNEUMATICI "AN"- "ANM"- "AMC"- "AM2C"- "ANDCB" PNEUMATIC FEEDERS "AN"- "ANM"- "AMC"- "AM2C"- "ANDCB"

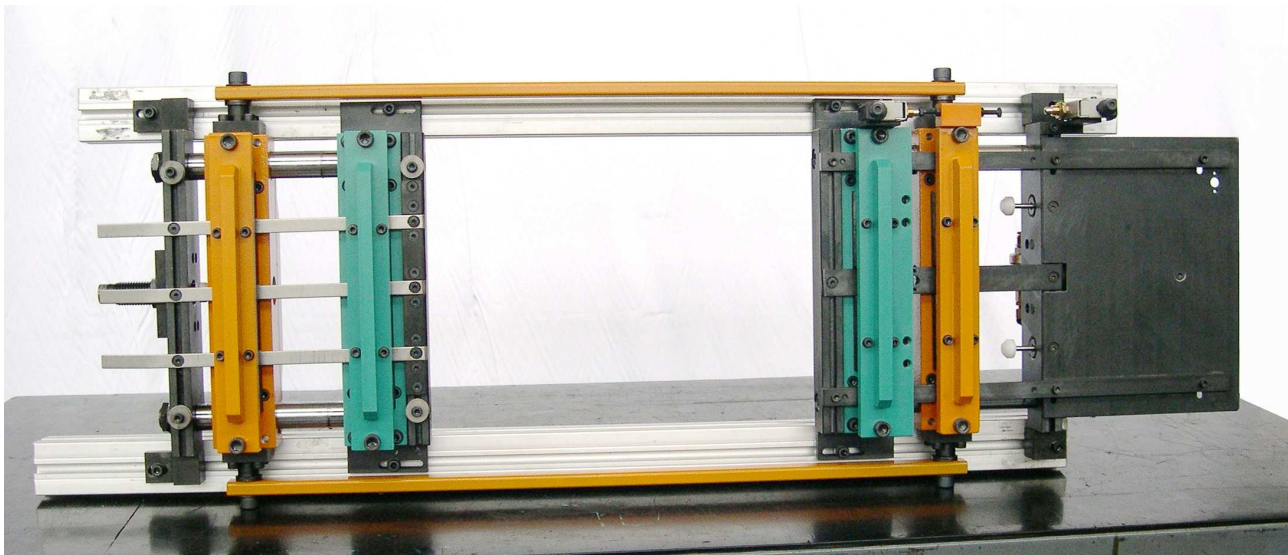
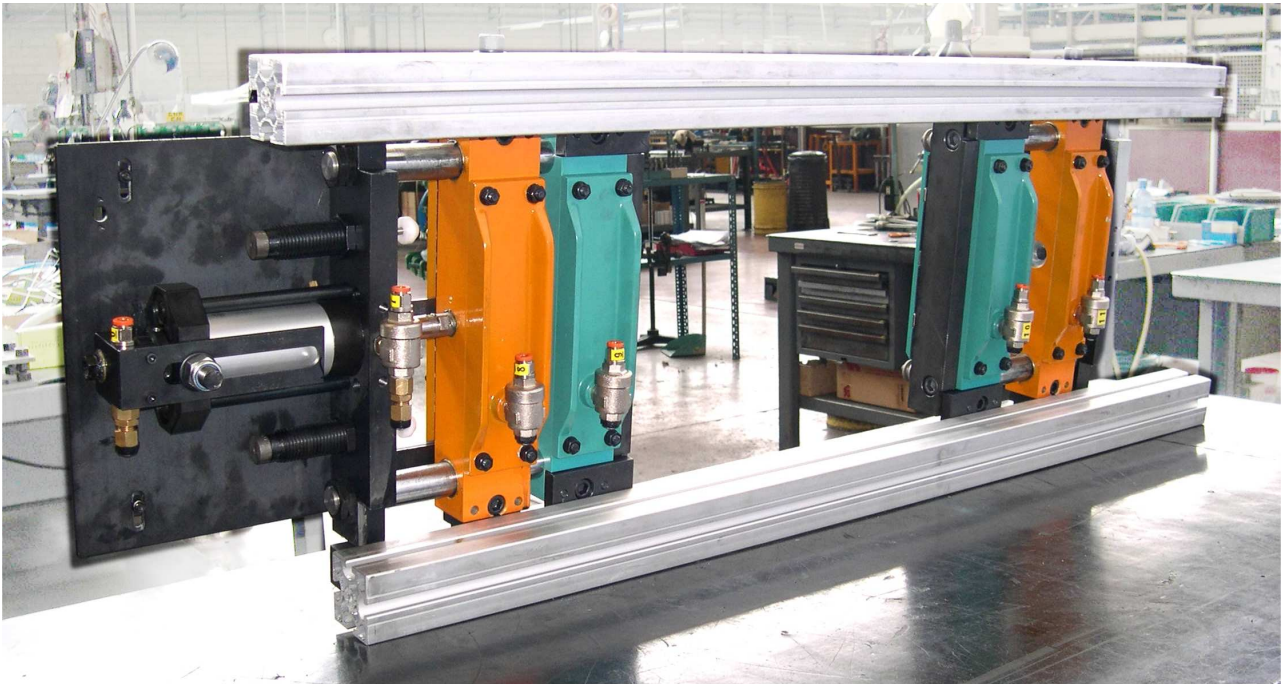

Photo: AP 035-00



**ALIMENTATORI PNEUMATICI "AN"- "ANM"- "AMC"- "AM2C"- "ANDCB"**  
**PNEUMATIC FEEDERS "AN"- "ANM"- "AMC"- "AM2C"- "ANDCB"**

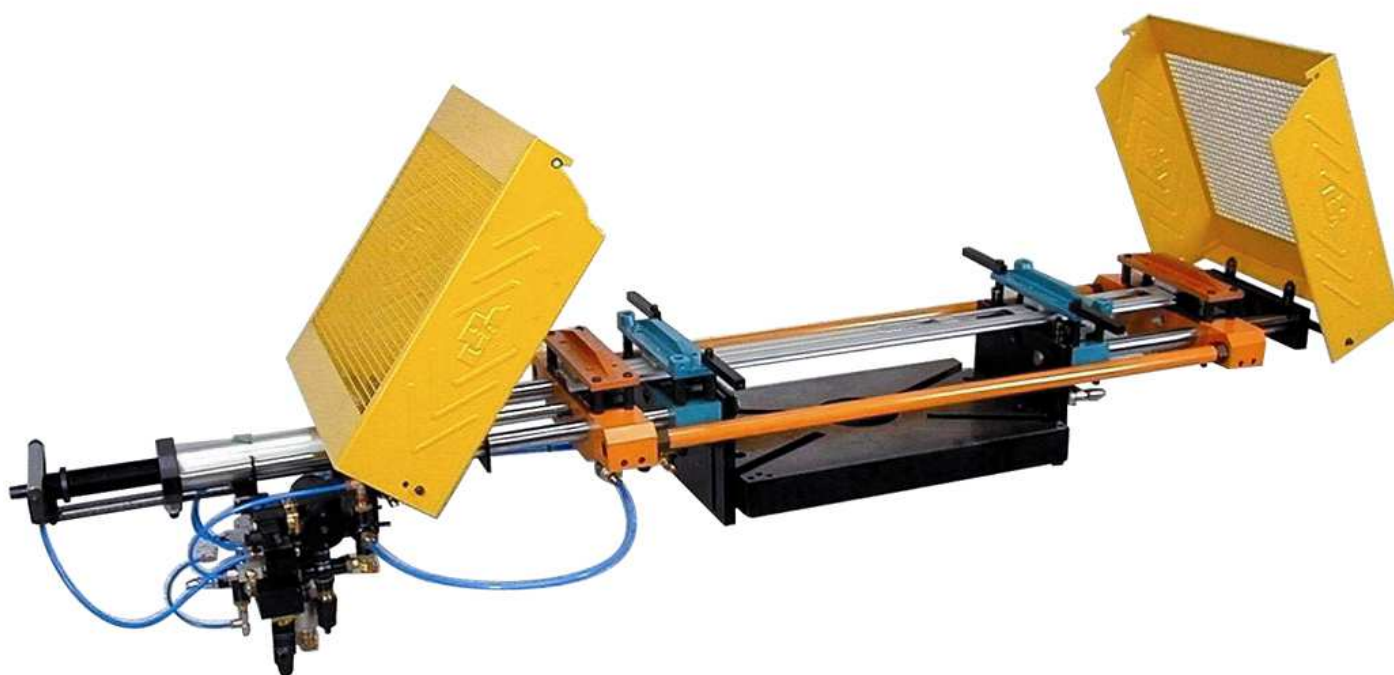

Photo: AP 036-00



**ALIMENTATORI PNEUMATICI “AN”-“ANM”-“AMC”-“AM2C”-“ANDCB”**  
**PNEUMATIC FEEDERS “AN”-“ANM”-“AMC”- “AM2C”-“ANDCB”**



Photo: AP 037-00



# ALIMENTATORI PNEUMATICI "AN"- "ANM"- "AMC"- "AM2C"- "ANDCB" PNEUMATIC FEEDERS "AN"- "ANM"- "AMC"- "AM2C"- "ANDCB"



Photo: AP 038-00



# ALIMENTATORI PNEUMATICI “AN”-“ANM”-“AMC”-“AM2C”-“ANDCB” PNEUMATIC FEEDERS “AN”-“ANM”-“AMC”- “AM2C”-“ANDCB”



- Alimentatori insonorizzati
- *Soundproof feeders*



# ALIMENTATORI PNEUMATICI “AN”-“ANM”-“AMC”-“AM2C”-“ANDCB” PNEUMATIC FEEDERS “AN”-“ANM”-“AMC”- “AM2C”-“ANDCB”

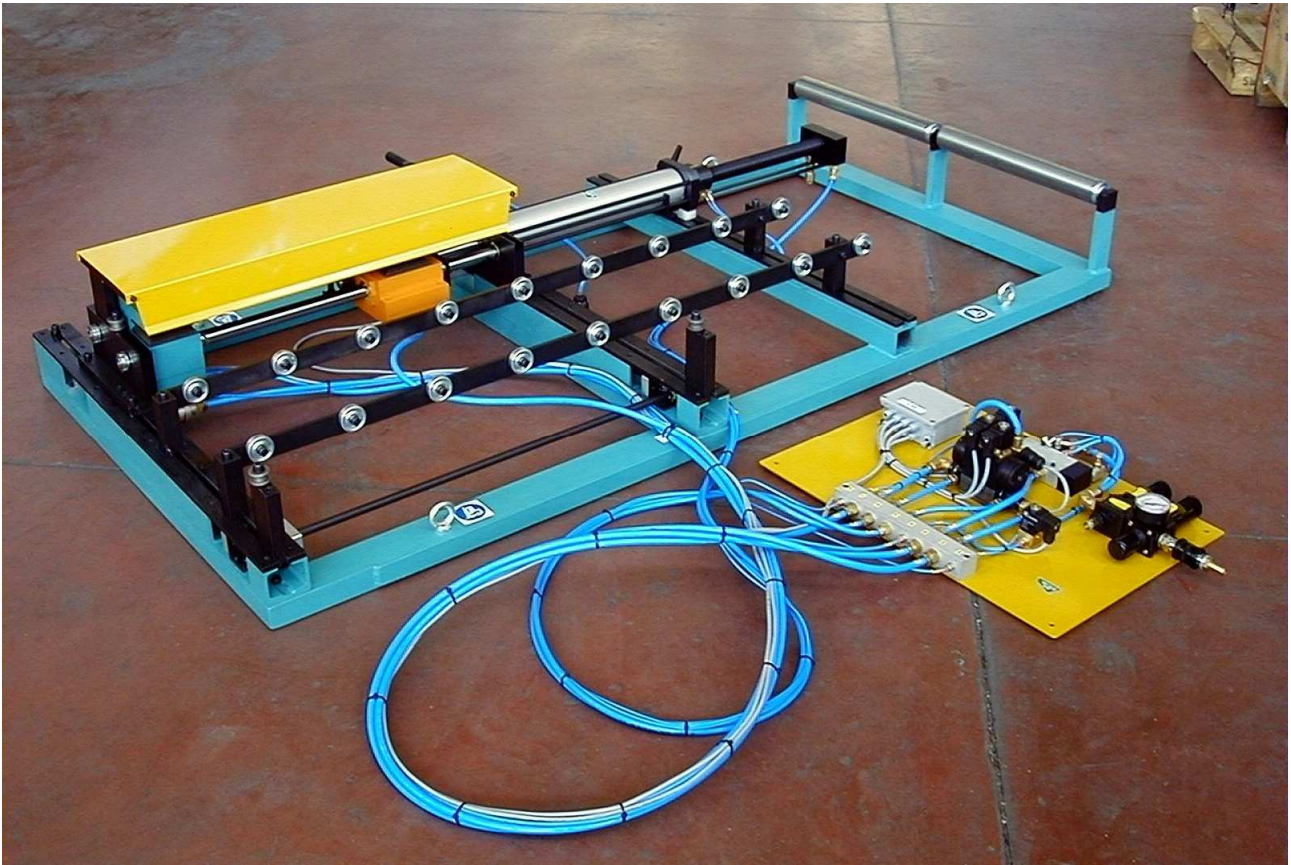

- Alimentatore pneumatico serie AMC 600x600 da posizionare su trancia con piano mazza inclinato
- *AMC 600x600 series pneumatic feeder to be assembled on shears with slanting ram plate*





**ALIMENTATORI PNEUMATICI “AN”-“ANM”-“AMC”-“AM2C”-“ANDCB”**  
**PNEUMATIC FEEDERS “AN”-“ANM”-“AMC”- “AM2C”-“ANDCB”**

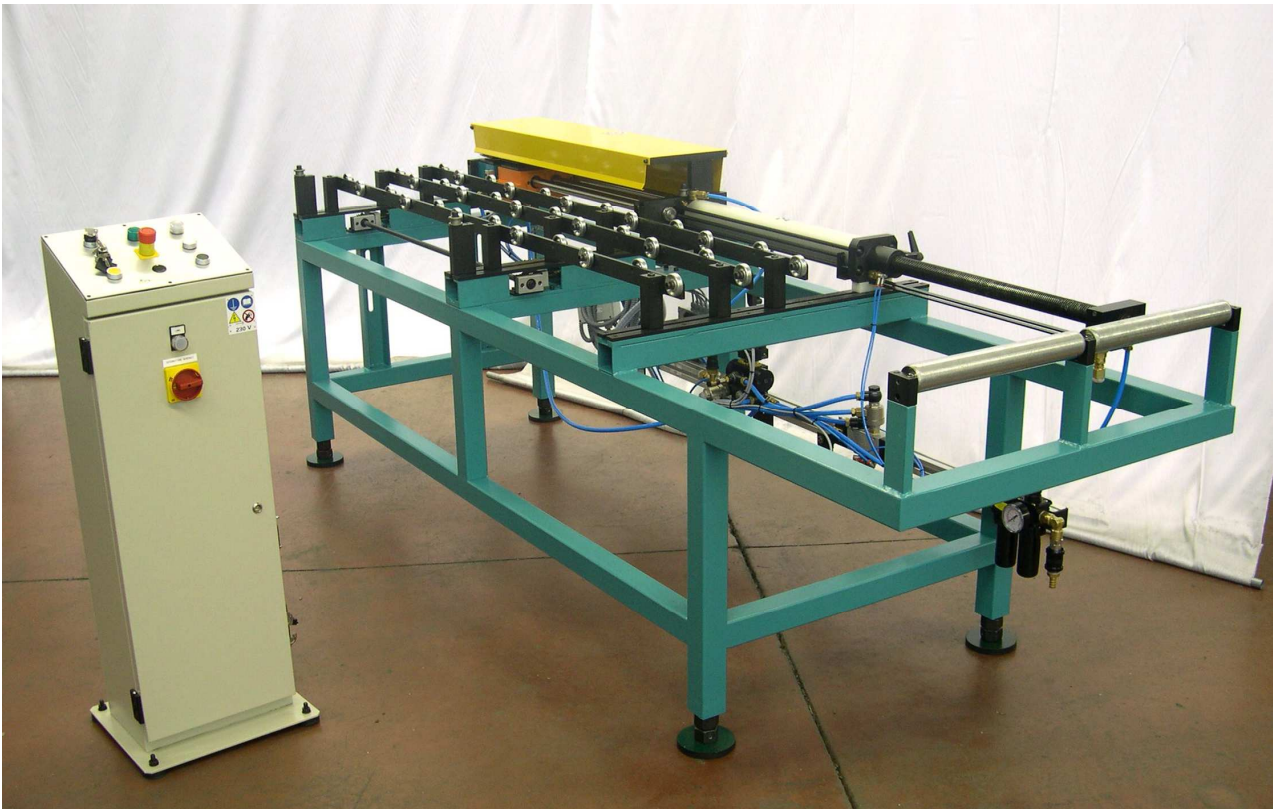

- Alimentatore pneumatico serie AMC 800x800
- *AMC 800x800 series pneumatic feeder*



**ALIMENTATORI PNEUMATICI “AN”-“ANM”-“AMC”-“AM2C”-“ANDCB”**  
**PNEUMATIC FEEDERS “AN”-“ANM”-“AMC”- “AM2C”-“ANDCB”**

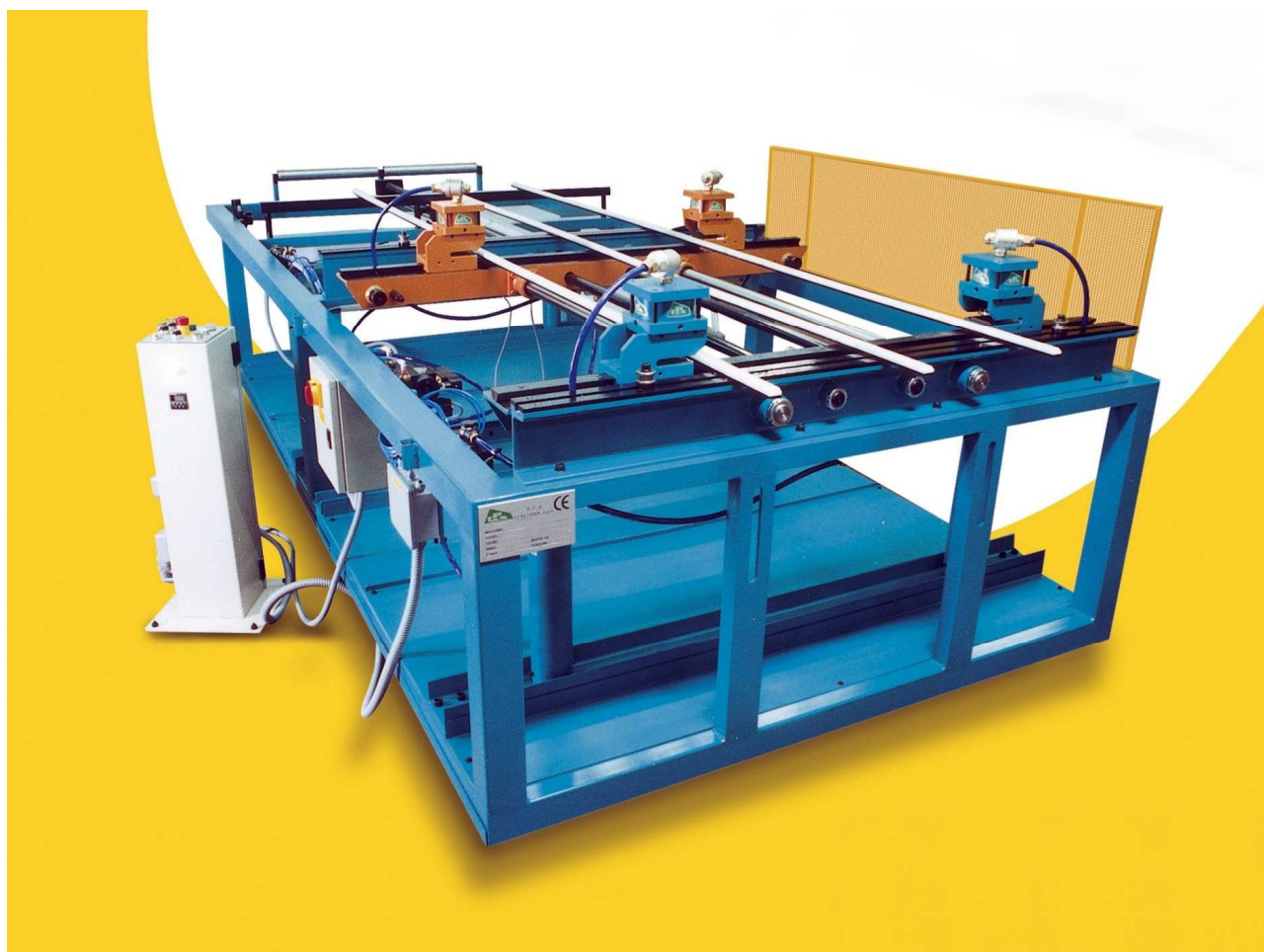

- Alimentatore pneumatico serie AM2C 1000x1000
- *AM2C 1000x1000 series pneumatic feeder*



**ALIMENTATORI PNEUMATICI “AN”-“ANM”-“AMC”-“AM2C”-“ANDCB”**  
**PNEUMATIC FEEDERS “AN”-“ANM”-“AMC”- “AM2C”-“ANDCB”**

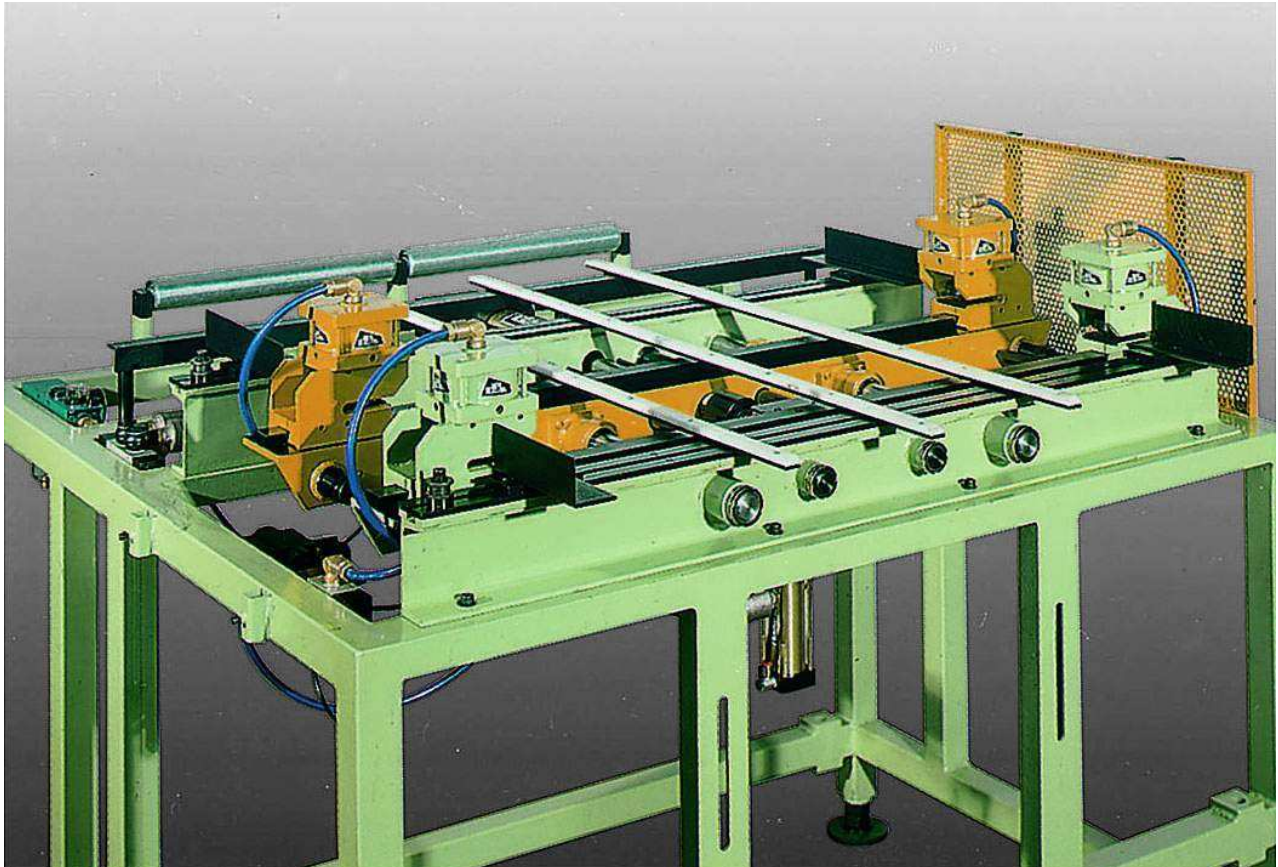

- Alimentatore pneumatico serie AM2C 1200x200
- *AM2C 1200x200 series pneumatic feeder*



# ALIMENTATORI CNC SERIE "ANM-E" CNC CLAMP FEEDERS "ANM-E" SERIES

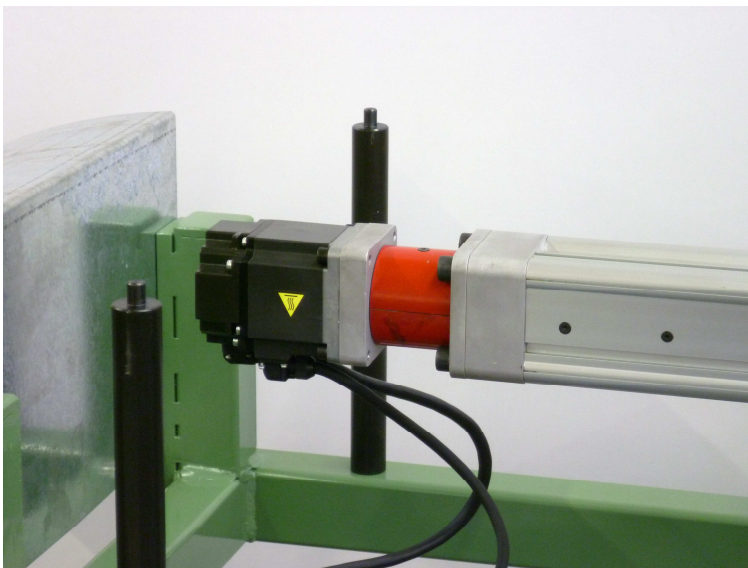
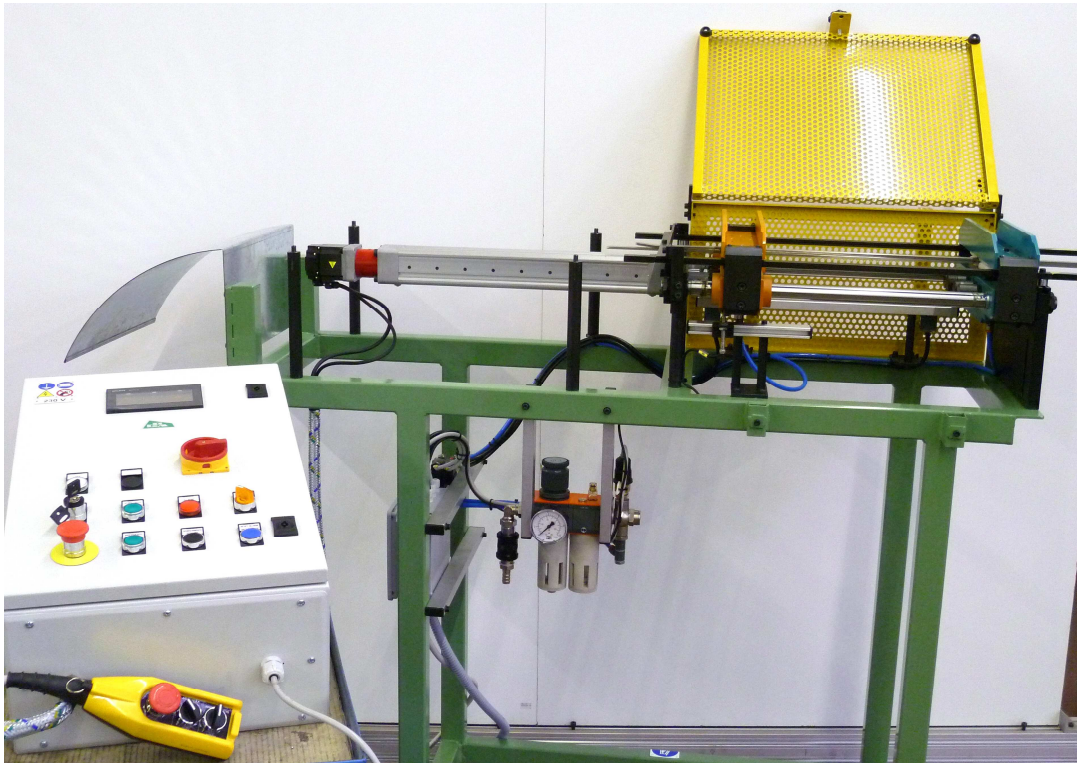

- Alimentatore elettropneumatico larghezza mm 300 passo mm 300 programmabile, velocità "rampe accelerazione", corse multiple
- *Electropneumatic feeder width mm 300 stroke mm 300 programmable, "acceleration ramp" speed, multiple strokes*



# ALIMENTATORI CNC SERIE "ANM-E" CNC CLAMP FEEDERS "ANM-E" SERIES

<https://youtu.be/8LnjUFAuYk>



Photo: AP 045-00



# ALIMENTATORI CNC SERIE "ANM-E" CNC CLAMP FEEDERS "ANM-E" SERIES

<https://youtu.be/JOwnC1seHeM>

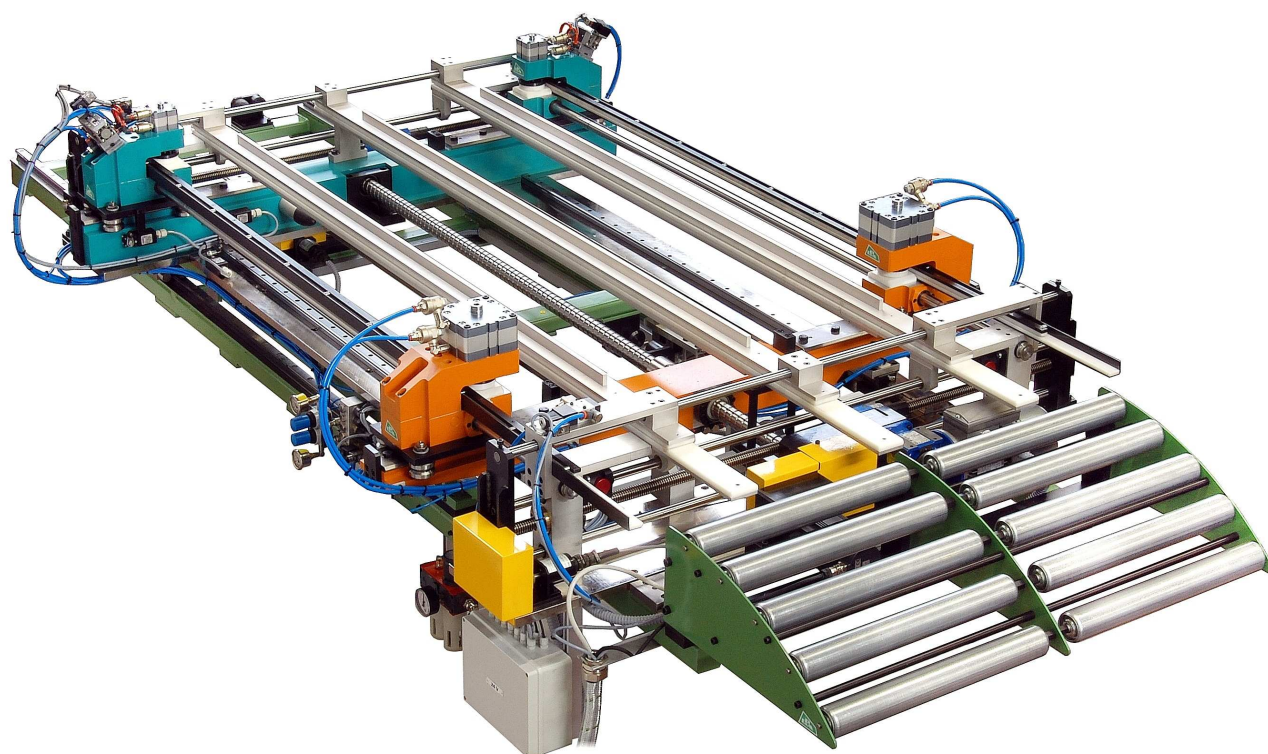
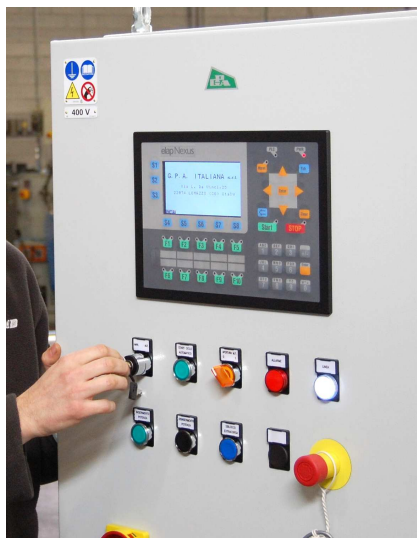

Photo: AP 046-00



# ALIMENTATORI CNC SERIE "ANM-E" CNC CLAMP FEEDERS "ANM-E" SERIES

<https://youtu.be/WnhBvA10Tlw>



- Alimentatore elettropneumatico mm 1200x1200 con regolazione passo e larghezza motorizzate programmabili da quadro pressa
- *1200x1200 mm electropneumatic feeder with programmable stroke and width adjustment by press control board*



# ALIMENTATORI ELETTRONICI A RULLI ELECTRONIC ROLL FEEDS



- Alimentatore elettronico larghezza mm 200
- *Electronic feeder mm 200 width*





# ALIMENTATORI ELETTRONICI A RULLI ELECTRONIC ROLL FEEDS



- Alimentatore elettronico larghezza mm 200 con cesoia
- *Electronic feeder mm 200 width with shears*



# ASPI SVOLGITORI DECOILERS



- Montaggio e collaudo aspi singoli e doppi
- *Decoilers and double decoilers assembling and testing*



# ASPI SVOLGITORI DECOILERS



- Montaggio e collaudo aspi personalizzati portata kg 500
- *Kg 500 capacity customized decoilers assembling and testing*



# ASPI SVOLGITORI DECOILERS

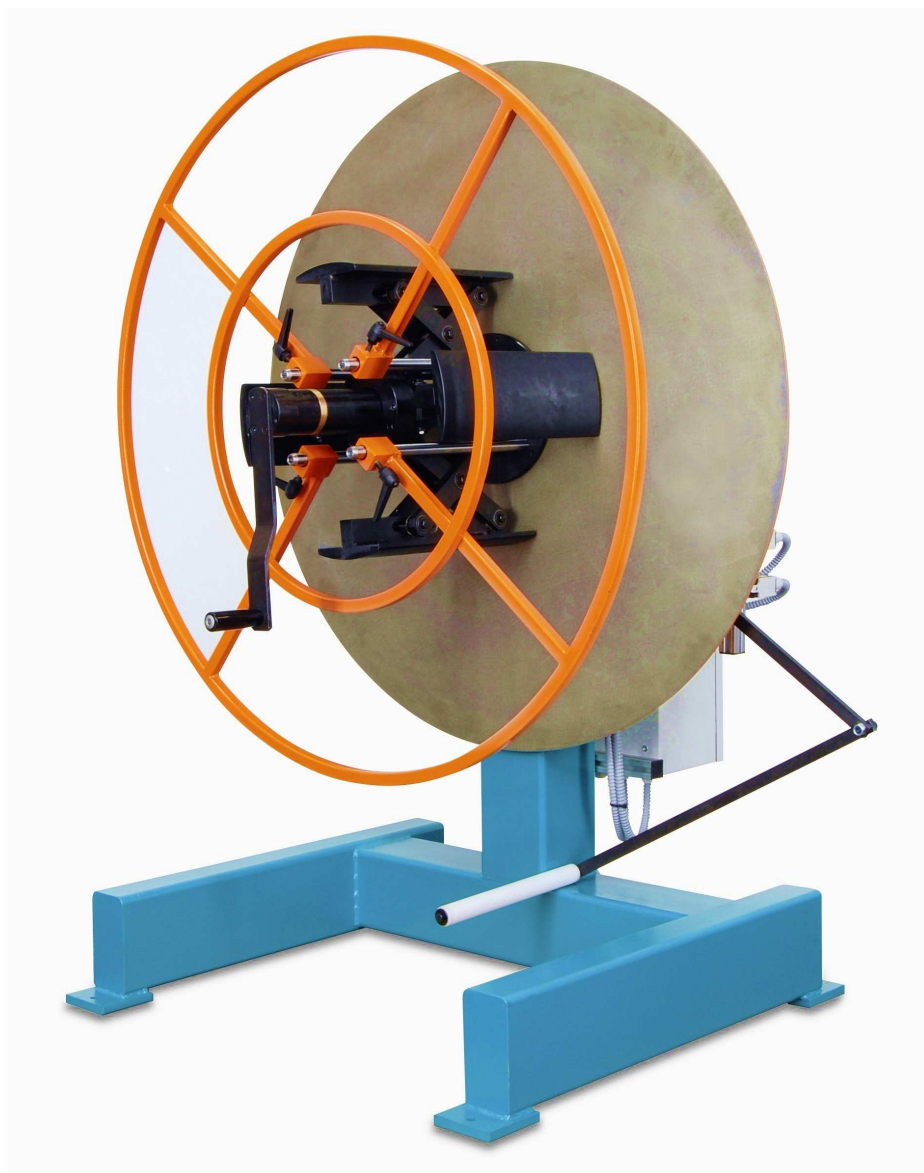

Photo: AP 052-00



# ASPI SVOLGITORI DECOILERS

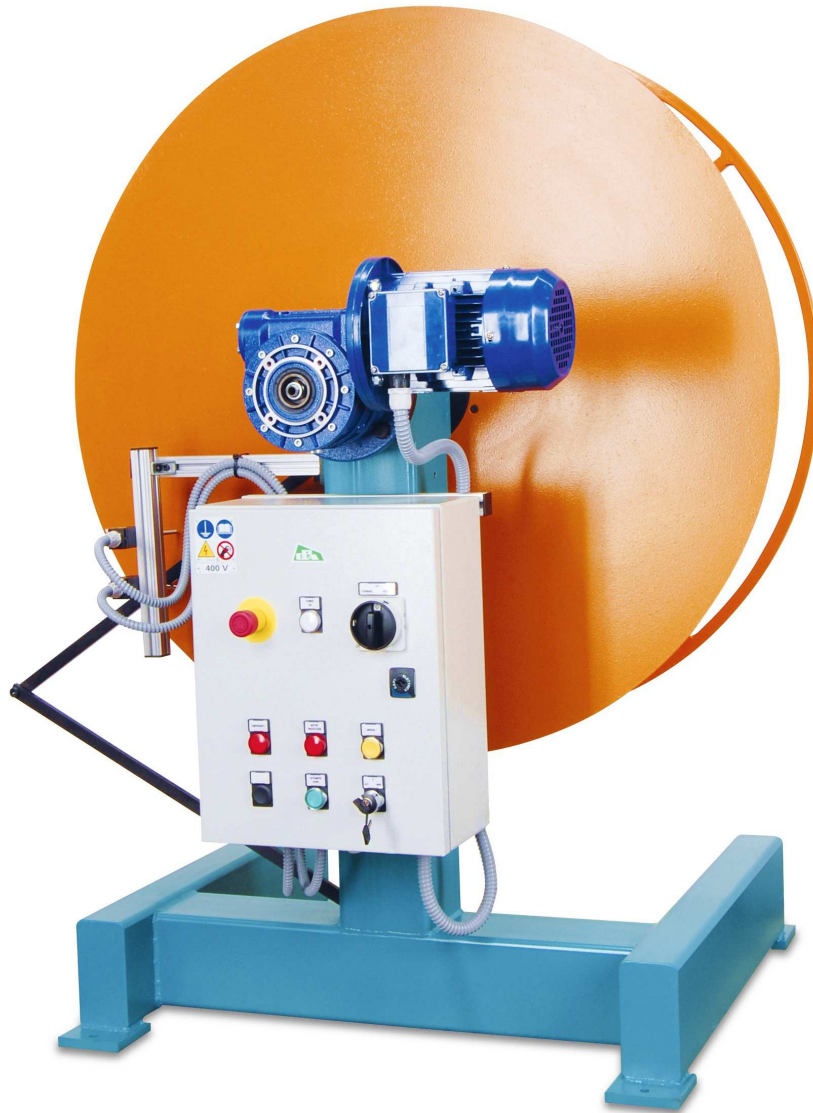
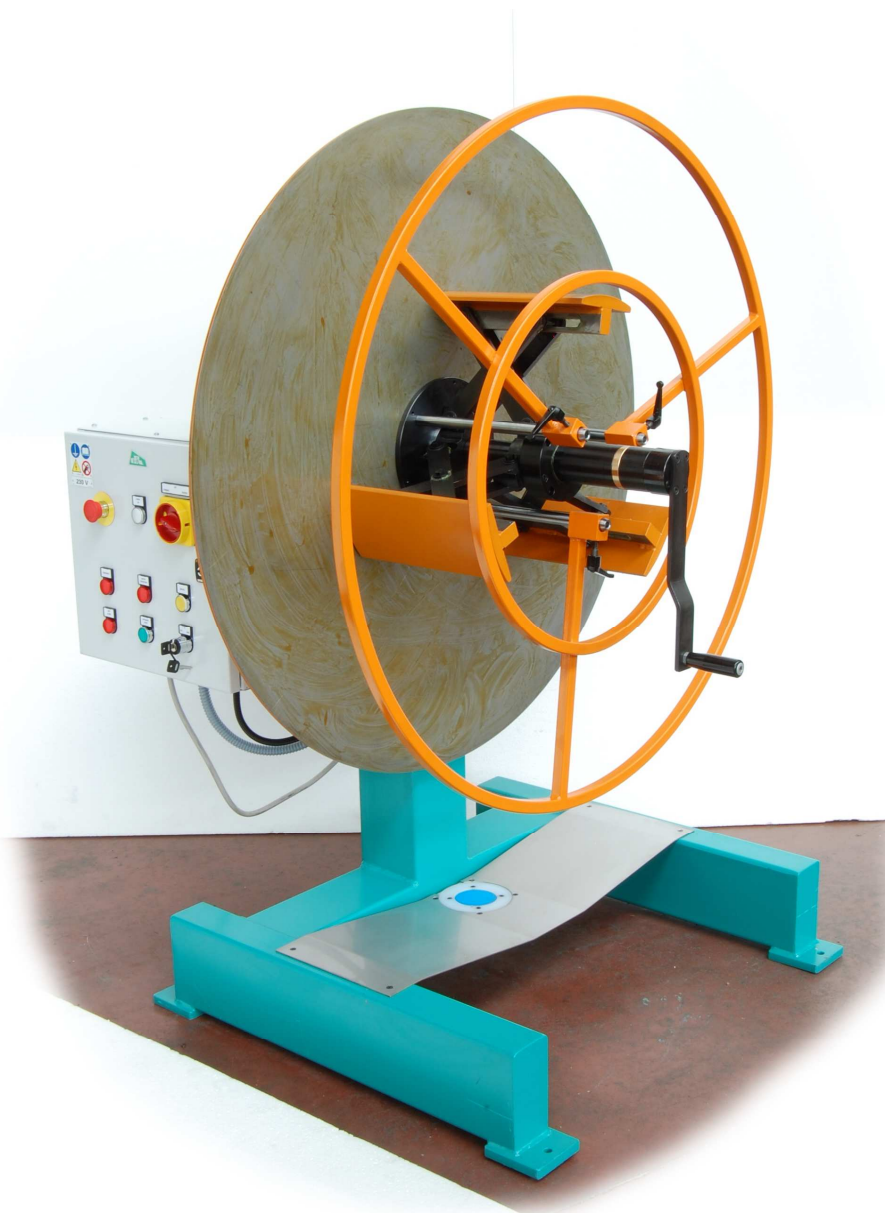

Photo: AP 053-00



# ASPI SVOLGITORI DECOILERS



- Aspo portata kg 300 larghezza mm 250
- *Kg 300 capacity decoiler width 250*



# ASPI SVOLGITORI DECOILERS

<https://youtu.be/U47AN-IJXi8>

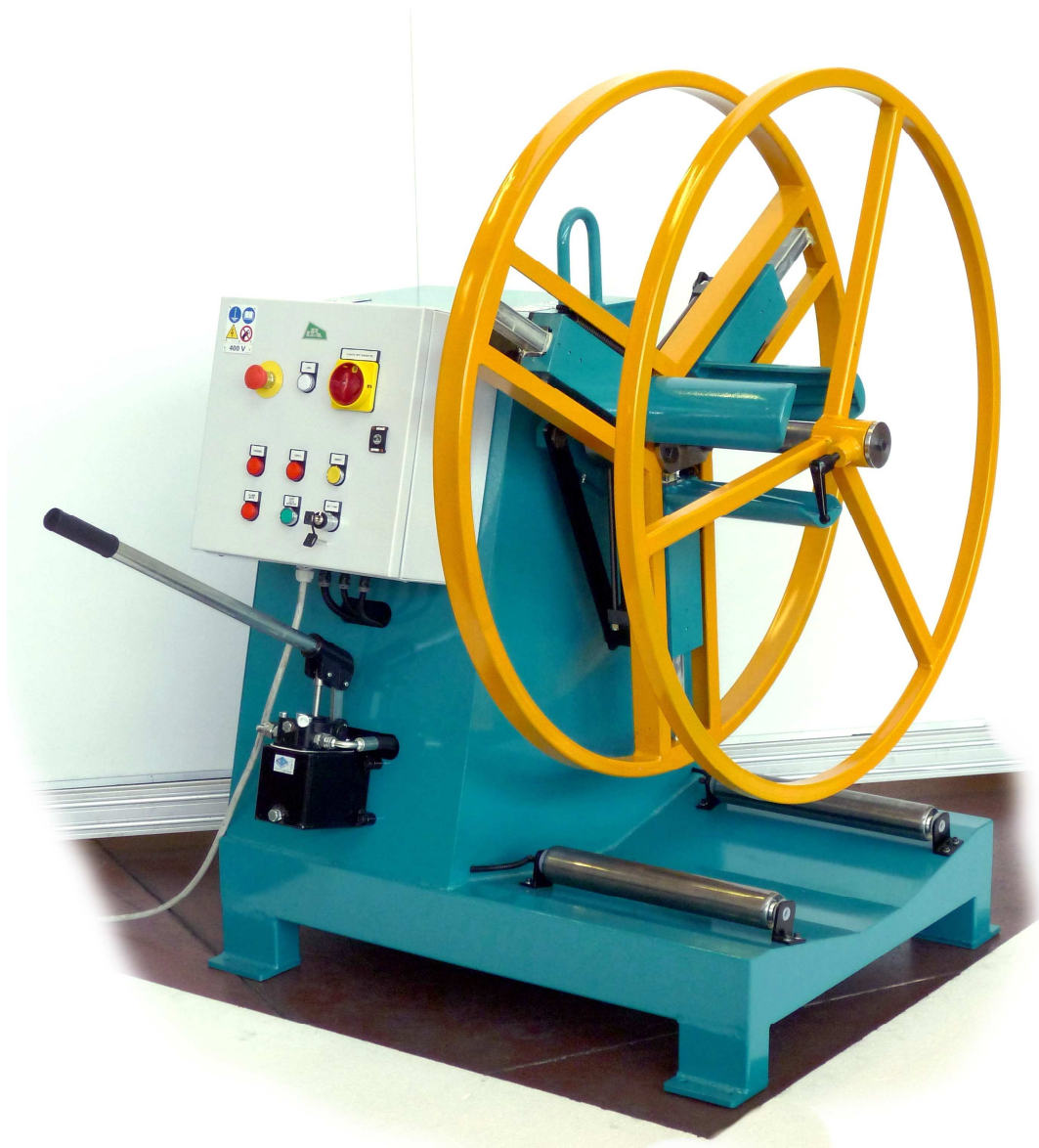

- Aspo portata kg 1000 larghezza mm 400 espansione idraulica manuale
- *Kg 1000 capacity decoiler width 400, manual jaws expansion*



# ASPI SVOLGITORI DECOILERS



- Aspo portata kg 1500 larghezza mm 400 braccio premiro-  
tolo espansione idraulica con centralina elettrica
- *Kg 1500 capacity decoiler width mm 400 coil holder harm,  
manual hydraulic opening with electrical power unit*





# ASPI SVOLGITORI DECOILERS

<https://youtu.be/p7CEbAtIXdM>

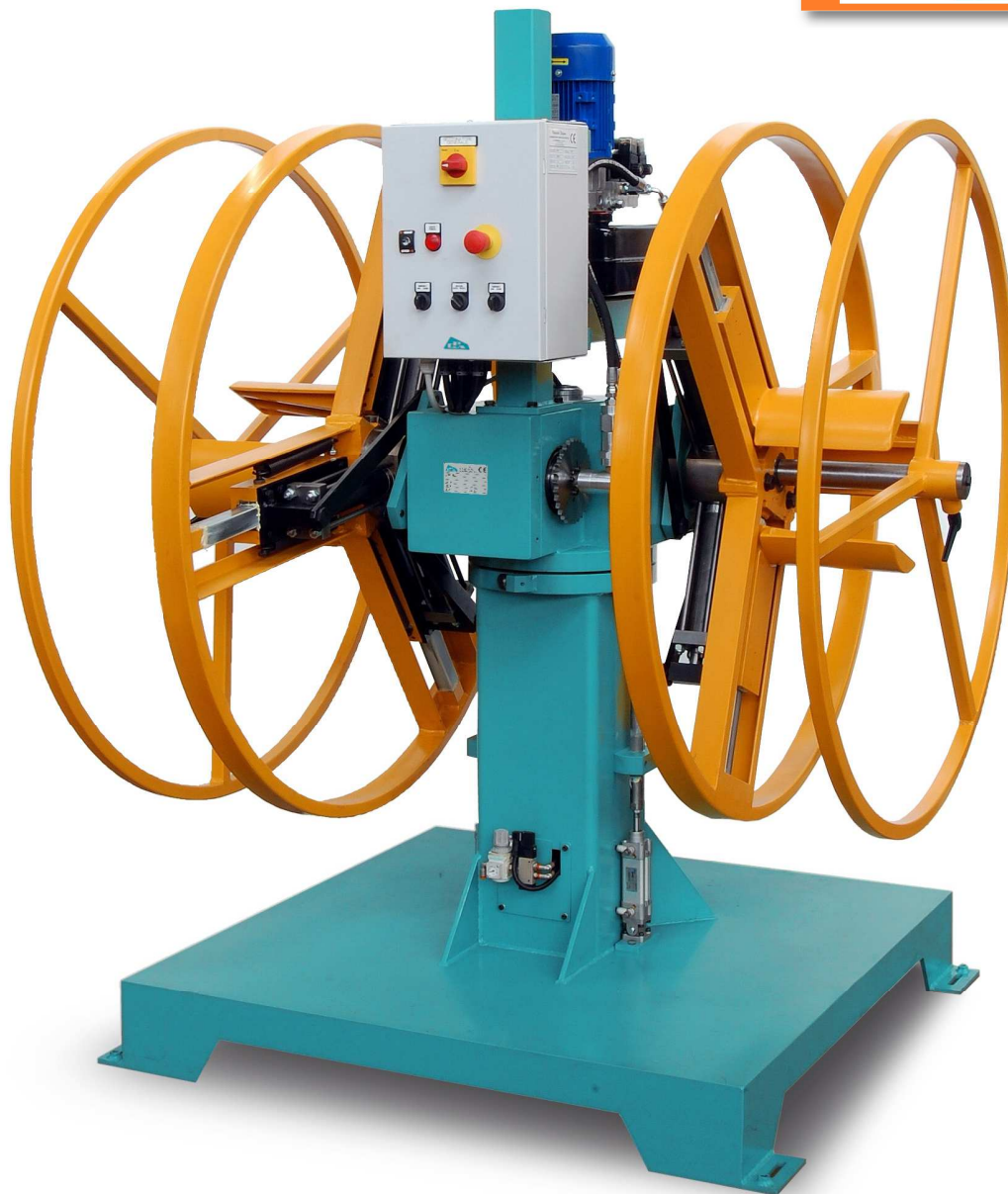

- Aspo portata kg 1000+1000 larghezza mm 200 espansione idraulica elettrica
- *Kg 1000+1000 capacity decoiler width mm 200 motorized hydraulic expansion*





**G.P.A. ITALIANA s.r.l.** Via L. Da Vinci, 25 - 22074 LOMAZZO (CO) ITALY  
Tel. +39 02 96779406 - [www.gpa-automation.com](http://www.gpa-automation.com) - e-mail: [gpa@gpa-automation.com](mailto:gpa@gpa-automation.com)